



User Instructions
CAPR® Systems



Copyright© Syntech International, Inc. All rights reserved.

For more Information:

U.S/ Canada/International

Telephone:

800-443-3842/ 949-752-9642

Fax:

949-752-9658

Website:

www.syntech-intl.com

E-mail:

info@syntechintl.com

Shipping/ Mailing Address:

Syntech International, Inc.
17171 Daimler Street
Irvine, CA 92614
USA

**** IMPORTANT - Please note WARRANTY AND TERMS AND CONDITIONS
regarding your MAXAIR Systems
by thoroughly reading the information on the MAXAIR Systems' Website ****

<https://www.maxair-systems.com>



Syntech International, Inc. Disclaimer

NOTE

THE GOODS COVERED BY THIS CONTRACT HAVE BEEN PURCHASED BY THE BUYER "AS IS" AND "WITH ALL FAULTS," AND THE BUYER ACKNOWLEDGES THAT NO WARRANTIES OF MERCHANTABILITY OR FITNESS FOR ANY PARTICULAR PURPOSE ARE TO BE IMPLIED IN THIS TRANSACTION.

THIS SALE IS MADE ON THE EXPRESS UNDERSTANDING THAT THERE IS NO IMPLIED WARRANTY THAT THE GOODS SHALL BE MERCHANTABILITY OR AN IMPLIED WARRANTY THAT THE GOODS SHALL BE FIT FOR ANY PARTICULAR PURPOSE. THE BUYER ACKNOWLEDGES THAT HE IS NOT RELYING ON THE SELLER'S SKILL OR JUDGMENT TO SELECT OR FURNISH GOODS SUITABLE FOR ANY PARTICULAR PURPOSE AND THAT THERE ARE NO WARRANTIES WHICH EXTEND BEYOND THE DESCRIPTION ON THE FACE HEREOF.

THE SELLER SHALL BE IN NO WAY RESPONSIBLE THE GOODS' PROPER USE AND SERVICE, AND THE BUYER HEREBY WAIVES ALL RIGHTS OF REFUSAL AND RETURN OF GOODS.

Any affirmation of fact or promise made by Seller shall not be deemed to create an express warranty that the goods shall conform to the affirmation or promise; any description of the goods is for the sole purpose of identifying them and shall not be deemed to create an express warranty that the goods shall conform to such description; any sample or model is for illustrative purposes only and shall not be deemed to create an express warranty that the goods shall conform to the sample or model; and no affirmation or promise, or description, or sample or model shall be deemed part of the basis of the bargain.

Syntech's exclusive distributor - Bio-Medical Devices International Inc. DBA MAXAIR Systems - has a warranty and return program that can be viewed online at: <https://maxair-systems.com/terms-and-conditions>.

Trademarks MAXAIR® and CAPR® are licensed to Syntech International, Inc.

Table Of Contents

1. Warnings, Cautions, Notes, Symbols	6
1.1 Important Information	6
1.2 S- Special or Critical User Instructions	7
1.3 SYMBOLS – General and Packaging	8
2. Regulatory Marking Definitions	9
3. Introduction	10
3.1 Part Numbers Reference	10
3.2 CAPR Systems	11
3.3. Applicability of Earlier Version Components and Assemblies	13
3.3.1 Filter Cover Cap (FCC), 2061-08 (01031284)	13
3.3.2 Lithium-Ion Batteries (LIBS) - 2500-36TSC (01532104) and 2500-30TSC (01532116)	14
3.4 Standard System Configuration Components and Order and Part Numbers	15
3.5 Helmets	16
3.5.1 Common Standard Helmet And Liner Characteristics	16
3.5.2 Helmet Assemblies	17
3.5.3 Characteristics Details (Refer to pages 20-21)	18
3.5.4 Helmet Symbol Definitions	20
3.6 Standard Face Cover, 2365-02SM/ML (01031291, 01031316), Overview	20
3.7 Battery, Belt, and Charger Overview	21
4. Decontamination / Cleaning	22
5. General System Maintenance and Storage	23
6. Battery Use, Maintenance and Storage	25
6.1 Routine Infection Control use in med/surg and ED areas	25
6.2 Emergency Preparedness (EP) and In-Frequent Use	25
6.3 General Use, Maintenance, and Storage	26
6.3.1 Recommended Temperature Ranges	26
6.3.2 Use/Discharge	27
6.3.3 Charge	27
6.3.4 Store	27
6.3.5 Handling and Transport	27
6.3.6 Useful Life	28
6.3.7 LIB Check Procedure - MAXAIR LIB Test for Diminishing Battery Capacity	28
6.3.8 Reference Information	29
6.3.9 Charging Protection from Electrical Surges	29
6.3.10 Projected LIB Level Available As A % At Initial Manufacture Versus Temperature	30
6.3.11 Glossary	30
7. Disposal	31
8. Unpacking Standard System Configuration Components and Parts Identification	32
8.1 Unpacking the 2081-03 (03531001, 03531021, 01031269, 2590-05)CAPR Helmet	32
8.2 Unpacking the 2500-36TSC (01532104) Battery	33
8.3 Unpacking the 2000-76 Battery Belt	34
8.4 Unpacking the 2600-02 (01432202) Battery Charger	35
8.5 Unpacking 2365-02SM (01031316) and 2365-02ML (01031291) DLC (Disposable Lens Cuff)	36
9. Standard System Configuration Set Up	38
9.1 Components Check List	38
9.2 Setting Up	38



9.3 Assemble and Disassemble Components 38
9.4 Inspections 39
9.5 Warning Device: Yellow LED Air Flow Indicator Check - Bouffant Cap Method 39
9.6 Warning Device: Yellow LED Air Flow Indicator Check - Tape Method 41

10. Standard System Configuration Assembly, Donning, and Doffing..... 42
11. Comfort Strips..... 46
12. Li-Ion Battery..... 47
13. Charger..... 48
14. Helmet..... 51
15. Helmet Liner..... 52
16. System Specifications..... 54

1. Warnings, Cautions, Notes, Symbols

1.1 Important Information

The words WARNING, CAUTION, and NOTE have special meanings and should be reviewed.

WARNING	The personal safety of the user may be involved. Disregarding this information could result in injury to the user.
CAUTION	These instructions point out special procedures or precautions and must be followed. Disregarding this information could result in jeopardizing the product reliability.
NOTE	Provide special information that supplements and/ or clarifies important instructions.
	A triangle with an exclamation point alerts the intended user to place extra emphasis on reading and understanding the accompanying instructions for operating, maintenance and safety information.

Warnings and Cautions



WARNING

This User Instructions and Instructions for Use, that accompany each package of system components, including the Warnings, Cautions and Special or Critical User Instructions, must be read thoroughly and followed carefully by all persons who have, or will have, the responsibility for using the system. The system will perform as designed only if it is used and maintained per the User Instructions. Failure to follow the User Instructions may be hazardous to the user's health.

NIOSH Cautions and Limitations

A Not for use in atmospheres containing less than 19.5% oxygen, or more than 25% oxygen.

B Not for use in atmospheres immediately dangerous to life or health.

C Do not exceed maximum use concentrations established by regulatory standards.

F Do not use powered air-purifying respirators if airflow is less than 4 CFM (115 LPM) for tight fitting face pieces or 6 CFM (170 LPM) for hoods and/or helmets.

I Contains electrical parts that may cause an ignition in a flammable or explosive atmosphere.

J Failure to properly use and maintain this product could result in injury or death.

L Follow the manufacturer's instructions for changing cartridges, canisters and/or filters.

M All approved respirators shall be selected, fitted, used, and maintained in accordance with MSHA, OSHA, and other applicable regulations.

N Never substitute, modify, add, or omit parts. Use only exact replacement parts in the configuration as specified by the manufacturer.

O Refer to User Instructions, and/or maintenance manuals for information on use and maintenance of these respirators.

P NIOSH does not evaluate respirators for use as surgical masks.

S Special or Critical User instructions and specific use limitations apply. Refer to User Instructions before donning.

1.2 S- Special or Critical User Instructions



WARNING

Special or Critical User Instructions

- NIOSH approved HE filters can be used for protection against particulate aerosols containing oil. However, Bio-Medical Devices Intl does not recommend use of MAXAIR Systems in oily atmospheres unless specifically indicated on the product.
- Do not use near flame or other heat source.
- The use of MAXAIR Systems in an alarm condition is only for immediate exit to a safe environment.
- During high energy work (exertion) rates, it is possible to over-breathe the MAXAIR System and create a negative pressure situation.
- If air flow is cut off, immediately hold your breath and immediately exit to clean air.
- In the power-off state, little or no respiratory protection is to be expected. Attempted use in this manner is an abnormal situation.
- In the powered-off state, rapid buildup of carbon dioxide and depletion of oxygen within the DLC system may occur.
- MAXAIR Systems' users must avoid situations where the Helmet, Power Cord, Battery or face/head cover (Cuff, Shroud, Hood) could become caught up simultaneously with a sudden and strong movement that could cause the Helmet to become dislodged from the users head and result in loss of respiratory protection.
- Materials of HFR Hoods are tested per ASTM F1671 and AATCC 127 to provide an indication of fluid resistance. NIOSH does not conduct this testing as part of their approval.



CAUTION

- When subjected to harsh use in critical environments (e.g. holding and dropping a battery by the power cord) the helmet-battery power cord will wear at a much faster rate than normal. In these types of circumstances, the power cord should be examined prior to each use, and it is recommended to be changed out every 30 days, or sooner if it becomes damaged or degraded.
- Do not operate in environments with temperatures exceeding 54°C
- A suitable environment is when an employee can work a full shift comfortably without any special paraphernalia other than normal clothing.
- Replace damaged or worn Filters immediately.
- Always start with a fully charged battery.
- Charge Li-Ion Battery in a MAXAIR Lithium-Ion battery charger only.
- The Helmet Power Cord should not be removed from its connection to the Helmet unless the Power Cord needs replacement.
- Do not immerse system components in liquid.
- Never use compressed air to clean any part of the MAXAIR System.
- There are no user-serviceable parts inside the Helmet and Li-Ion Battery. Do not attempt to disassemble, open or service the Helmet and Li-Ion Battery. Call Customer Service, 1-800-443-3842, for assistance.

1.3 SYMBOLS – General and Packaging

1		European market “CE” and notified body number “0194”.	18		Catalog Number
2		National Institute for Occupational Safety and Health.	19		NIOSH Number
3		Refer to approval label and User’s instructions for cautions, limitations, and approved assembly configurations.	20		Batch Code
4		High Efficiency.	21		Quantity
5		Use By	22		Order Number
6		Material Fluid Resistance	23		Authorized representative in the European community.
7		Consult instructions for use (IFU)	24		Indoor Use Only
8		Consult User Instructional Manual (UIM) of MAXAIR System	25		Type L and Type R Listing Marks for Canada and the United States
9		Do Not in environments requiring intrinsic safety	26		UL Recognized Component Marks for Canada and the United States.
10		Place of Manufacture	27		European EMC testing to EN60601-1
11		Date of Manufacture	28		Caution, risk of electrical shock. High Voltage.
12		Storage Kept Dry. Keep away from rain.	29		Double insulation
13		Storage Humidity Upper limitation.	30		Recyclable.
14		Storage Temperature limitation.	31		Caution, Warning
15		Battery: Operational Upper limit of temperature.	32		British Standard: Respiratory protective devices- Powered filtering devices incorporating a helmet or a hood.
16		Per Directive 2002/96/EC, product must be collected separately. Do not dispose of as unsorted municipal waste. Contact local distributor for disposal information.	33		Charging
17		Per Directive 2006/66/EC, collect and recycle batteries/ battery packs according to EU Member State regulations.	34		Charge Complete.

2. Regulatory Marking Definitions

Filter markings and colors contain shared and unique information respective to the NIOSH.

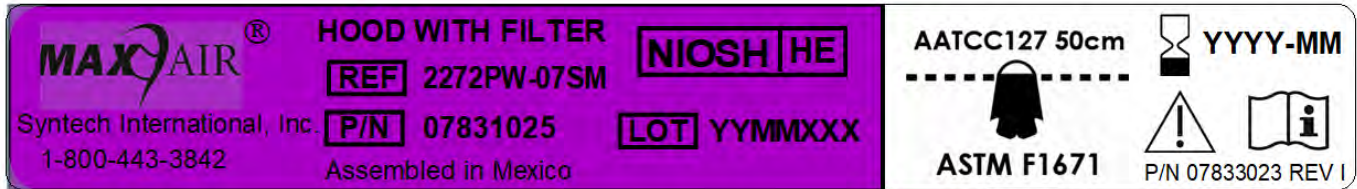
**NOTE**

Artwork Shown is for Reference Only.

NIOSH (Contents within magenta background): MAXAIR Systems provide HE- High Efficiency Particulate Air Filtering per NIOSH 42 CFR 84.

- "HE" and "NIOSH" are specific terminology for Filter Protection Classifications per NIOSH VFR.
- Purple label background color is specific to NIOSH Filter color coding requirement per ANSI Z88.7-2001.

Contents outside of magenta background: The user should not confuse the markings on a filter relating to any standard other than EN 12941 with the classification of this device when used with the corresponding filter.

- "EN12942, TH2P R S" are specific terminology for Filter Protection Classification per EN 12941:1998 + A2 : 2008.
- White label background is specific to Filter color coding requirements per EN 12941:1998 + A2 : 2008.

**CAUTION**

The purchaser/user is responsible for determining the appropriateness of the CAPR System for each/any of their particular applications/environments.

3. Introduction

3.1 Part Numbers Reference

Catalog Numbers, indicated by the symbol **REF**, are used throughout the User Instructions descriptive text; NIOSH Numbers are indicated by the symbol **P/N**. Table 1 lists the Catalog Numbers and respective NIOSH Numbers for each component.

Table 1. Part Number Reference Chart

DESCRIPTION	REF	P/N
HELMETS		
CAPR (turnlock w/Cage, Liner, and Power Cord)	2081-03	03531001 (03531154 Assembly) 03531021 Liner 01031269 Cage 2590-05 Power Cord
CAPR (turnlock w/Cage, ChinBar Liner, and Power Cord)	2082-03	03531001 (03531142 Assembly) 03531104 ChinBar Liner 01031269 Cage 2590-05 Power Cord
CAPR (turnlock w/Cage, Hard Hat Liner, and Power Cord)	2083-03	03531001 (03531228 Assembly) 03531148 Liner 01031269 Cage 2590-05 Power Cord
CAPR (turnlock w/Cage, Liner, Power Cord, PR Adapters)	2084-03	03531001(07631208 Assembly) 03531148 Liner 01031269 Cage 2590-05 Power Cord
POWER CORDS		
POWER CORD (Turnlock, 59 inch)	2590-05	2590-05
POWER CORD (Turnlock, 47 inch)	2590-08	00722182
LINERS		
LINER (Standard)	2071-08	03531021
LINER (ChinBar)	2071-02	03531104
LINER (Hard Hat)	2071-07	03531148
BATTERIES		
LITHIUM ION BATTERY	2500-30TSC	01532116
LITHIUM ION BATTERY	2500-36TSC	01532104
LITHIUM ION BATTERY	2500-37TSC	01532161
BELT		
BATTERY BELT, 69 inch	2000-76	2000-76
BATTERY BELT, 70 inch, cleanable	2000-77	03931009
BATTERY BELT, 50 inch, cleanable	2000-78	03931010
CHARGERS		
SINGLE CHARGER	2600-01	01432089
SINGLE CHARGER	2600-02	01432202
ACCESSORIES		
COMFORT STRIPS	2000-201	2000-201

3.2 CAPR Systems

Systems are configured from four main items, a Helmet, a Battery, a Battery Belt, and a Battery Charger.

- Battery Belts: 2000-76, 2000-77, 2000-78.
- Battery Chargers: 2600-02, 2600-01.
- Li-Ion Batteries: 2500-36TSC, 2500-37TSC, 2500-30TSC.
- Helmets: 2081-03, 2082-02, 2083-03, and 2084-03.

Standard System configurations include:

Table 3. Standard SYSTEMS and their COMPONENTS

ITEM	REF	P/N	DESCRIPTION
CA-DLC-CAPR-36			
1	2081-03	03531001 Helmet 03531021 Liner 01031269 Cage 2590-05 Power Cord	Helmet Assembly
2	2500-36TSC	01532104	Li-Ion Battery
3	2000-76	2000-76	Battery Belt
4	2600-02	01432202	Li-Ion Battery Charger
CA-DLC-CAPR-37			
1	2081-03	03531001 Helmet 03531021 Liner 01031269 Cage 2590-05 Power Cord	Helmet Assembly
2	2500-37TSC	01532161	Li-Ion Battery
3	2000-76	2000-76	Battery Belt
4	2600-02	01432202	Li-Ion Battery Charger

ITEM	REF	P/N	DESCRIPTION
CA-DLC-CAPR-HH-36			
1	2083-03	03531001 Helmet 03531148 Liner 01031269 Cage 2590-05 Power Cord	Helmet Assembly
2	2500-36TSC	01532161	Li-Ion Battery
3	2000-76	2000-76	Battery Belt
4	2600-02	01432202	Li-Ion Battery Charger
CA-DLC-CAPR-HH-37			
1	2083-03	03531001 Helmet 03531148 Liner 01031269 Cage 2590-05 Power Cord	Helmet Assembly
2	2500-37TSC	01532116	Li-Ion Battery
3	2000-76	2000-76	Battery Belt
4	2600-02	01432202	Li-Ion Battery Charger



ITEM	REF	P/N	DESCRIPTION
2084-36TSC			
1	2084-03	03531001 Helmet 03531021 Liner 01031269 Cage 2590-05 Power Cord	Helmet Assembly
2	2500-36TSC	01532161	Li-Ion Battery
3	2000-76	2000-76	Battery Belt
4	2600-02	01432202	Li-Ion Battery Charger
2084-37TSC			
1	2084-03	03531001 Helmet 03531021 Liner 01031269 Cage 2590-05 Power Cord	Helmet Assembly
2	2500-37TSC	01532116	Li-Ion Battery
3	2000-76	2000-76	Battery Belt
4	2600-02	01432202	Li-Ion Battery Charger

3.3. Applicability of Earlier Version Components and Assemblies

3.3.1 Filter Cover Cap (FCC), 2061-08 (01031284)

The current version FCC, 2061-08, includes a right-side and a left-side snap on the rear half of the FCC Skirt (A), a front Turn-Clip Adapter(B), and a modified side Adapter C.

The snaps are to secure the top of the DLC-Shroud and DLC-Double Shroud, 2260-05ML/SM and 2261-01ML/SM, respectively. These snaps were included in the most recent 2061-03 version as well.

The front Turn-Clip adapter, added only on the 2061-08, eliminates the need to change front adapters when switching between Cuff & Shroud configurations and Hood configurations.

The original version of the 2061-03 FCC does not include these snaps (A) or the front adapter(B) and must not be used with the DLC-Shroud and DLC-Double Shroud, 2260-05ML/SM and 2261-01ML/SM, respectively.

When upgrading older DLC CAPR Systems to use them with the DLC-Shroud and DLC-Double Shroud, 2260-05ML/SM and 2261-01ML/SM, respectively, you must upgrade to the new 2061-08 FCC.



NOTE

The new version of the 2061-03 FCC was included with your 2074-04 Helmet Kits and 2061-03 FCCs if purchased after September 2012.



WARNING

If you have CAPR Helmets with Filter Cover Caps, 2061-03, with lot numbers with a lower number than 1209007-N, inspect them for the presence of the rear snaps on each side (A). If they are not there, you must replace those FCCs with newer versions with the snaps to safely use the DLC-Shroud and DLC-Double Shroud, 2260-05ML/SM and 2261-01ML/SM, respectively, with your CAPR Helmets.

2061-08



2061-03



3.3.2 Lithium-Ion Batteries (LIBS) - 2500-36TSC (01532104) and 2500-30TSC (01532116)

The 2500-36TSC supersedes the 2000-36 and 2000-36T LIBs.

The 2500-30TSC supersedes the 2000-30 and 2000-30T LIBs.

The functionality and performance of the 2500 Series LIBs is equivalent to those LIBs they supersede and they may be used interchangeably relative to performance and application.



CAUTION

The power cord for the 2500 Series LIBs has a different cord-to-battery connector (A) and this cord must be used with the 2500 Series LIBs, and not the older cord (B). The new cord is also compatible with the older style LIBs.

The older cords do not connect reliably with the 2500 Series LIBs and must not be used with these new LIBs.

When you purchase a 2500 Series LIB you will receive new power cords for each of the MAXAIR Helmets you have purchased over time. You must discard all older power cords when you receive your new 2500 Series LIBs to ensure you are always using the correct connector, regardless of newer or older battery.

Exchange Power Cords on 2070-03 and 2075-03 Helmets Only

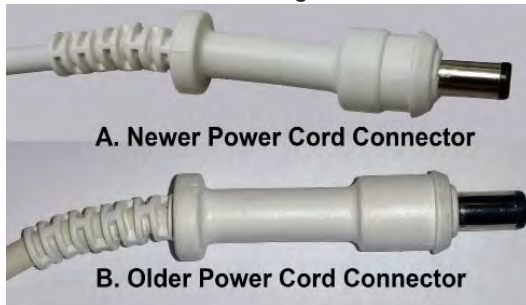

1. Firmly grasp the flat sides of the older Power Cord-to-Helmet Connector.



2. Firmly lift the Power Cord-to-Helmet Connector up and out of the Helmet receptacle.

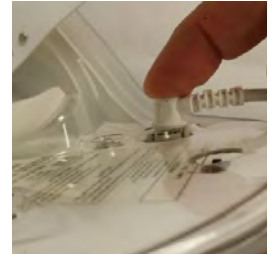

3. Place the newer Power Cord-to-Helmet Connector into the Helmet receptacle and push in until it is firmly seated.



NOTE

The 2500 Series LIBs incorporate a Secure Lock Button and mechanism that securely locks the power cord connector, from the helmet, into the battery connector. The operation of this Secure Lock Button is described in all appropriate sections of the User Instructions.



If you have questions about the newer versions described in this section, please contact Customer Service at info@maxair-systems.com, or 1-800-443-3842.

3.4 Standard System Configuration Components and Order and Part Numbers

The MAXAIR® Systems CAPR® Systems are multi-application air-purifying, Li-Ion Battery powered particulate respirators that optimize user safety, convenience, ease-of-use, and cost effectiveness.

The CAPR loose fitting Powered Air Purifying Respirator (PAPR) System configurations are for filtering aerosolized and droplet particulates from otherwise breathable air.



ITEM	REF	P/N	DESCRIPTION
1	2081-03 ^A	03531001 03531021 01031269 2590-05	Helmet Assembly, consisting of - Helmet Liner Cage Power Cord
2	2051-07 ^{A,B}	01031269	Cage (SnapOn)
3	2071-08 ^A	03531021	Liner
4	2590-05 ^A	2590-05	Power Cord
5	2500-36TSC	01532104	Li-Ion Battery
6	2000-76	2000-76	Battery Belt
7	2600-02	01432202	Li-Ion Battery Charger

A Each 2081-03 Helmet ships with a 2071-08 Helmet Liner, 2051-07 Cage, and 2590-05 Power Cord assembled to the helmet.
 B The Cage provides shipping protection and is used with Hood Configurations. For Shroud and Cuff configurations the Cage is removed and replaced with an appropriate Filter Cartridge.

3.5 Helmets

3.5.1 Common Standard Helmet And Liner Characteristics

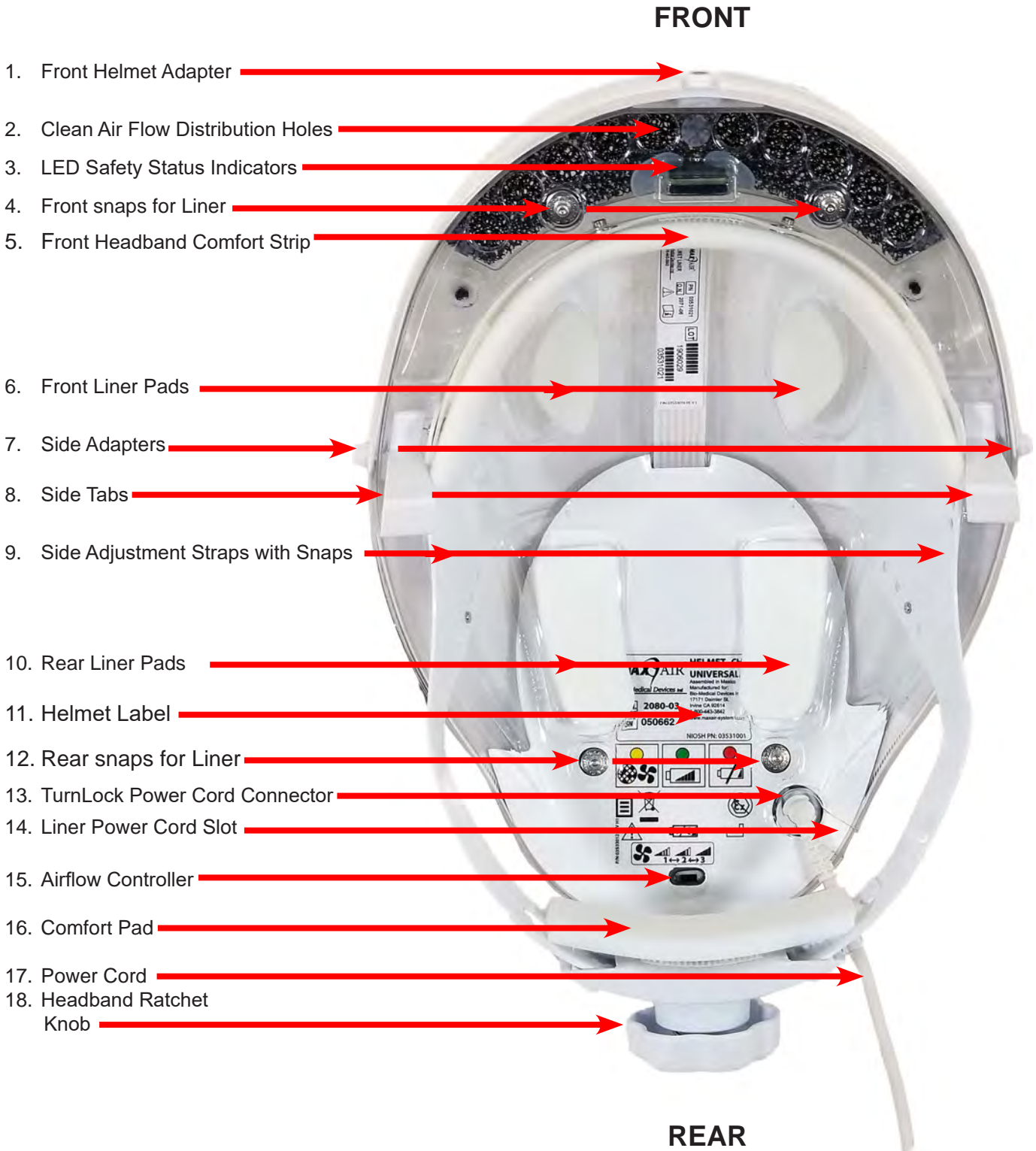

3.5.2 Helmet Assemblies

2081-03 Helmet with SnapOn Cage



- 03531001 Helmet
- 2051-07 Filter Frame (Cage)
- 2071-08 Liner
- 2590-05 Power Cord

2082-03 Helmet with SnapOn Cage and ChinBar Liner



- 03531001 Helmet
- 2051-07 Filter Frame (Cage)
- 2071-02 ChinBar Liner
- 2590-05 Power Cord

2084-03 Helmet with SnapOn Cage



- 03531001 Helmet
- PR Hood Adapters
- 2051-07 Filter Frame (Cage)
- 2071-08 Liner
- 2590-05 Power Cord

2083-03 Helmet with SnapOn Cage



- 03531001 Helmet
- 2051-07 Filter Frame (Cage)
- 2071-07 Liner
- 2590-05 Power Cord



Liner, Standard Pads

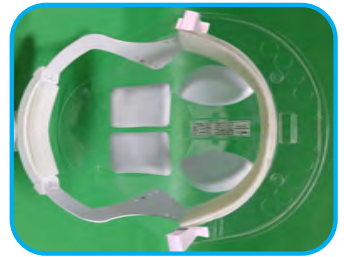

Liner, Large (HH) Pads

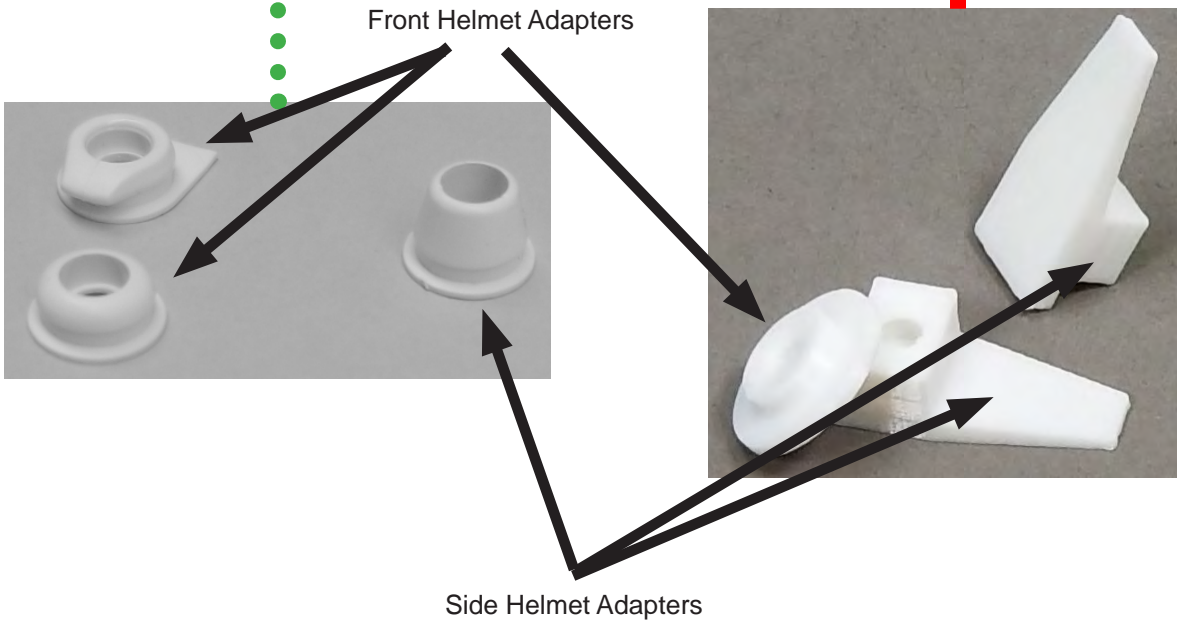

3.5.3 Characteristics Details (Refer to pages 20-21)

1 Front Helmet Adapter - For assembly of Hoods to Helmet

2 Clean Air Flow Distribution Holes - 10 air vents bringing filtered air to the user.

3 LED Safety Status Indicators



WARNING

Failure to heed the LED Safety Status Indicators and exit immediately to a safe environment when alarm conditions are present may be hazardous to the user's health. When Green LEDs are not lighted, the user should immediately exit to a safe area to obtain a recharged Battery.

- The CAPR Helmet has five LED Safety Status Indicators located on its underside front that are always visible in the user's peripheral vision. They alert the user to the safe operating conditions of the system. They will provide an early warning alert to the user when the CAPR Helmet is no longer able to maintain adequate airflow and/or Battery charge to provide adequate or continuing protection for the user.
- There are five LED Safety Status Indicators, one yellow, three green, and one red. On start-up, all LED's should come on briefly (LED test) before proceeding to normal operation. During normal operation, the LEDs continuously indicate the status of the Airflow and Battery charge level.
- Airflow is proper if the Yellow LED is off. A continuously lit or flickering Yellow LED indicates low or marginal airflow. If the Yellow LED is lit, check the Filter Cartridge for excess particulate/dirt build-up and damage, and replace if necessary.
- The Battery charge level is indicated by the three Green and one Red LEDs. The approximate charge level is continuously indicated by the changing LEDs.

CONDITION	DESCRIPTION	YELLOW	GREEN 3	GREEN 2	GREEN 1	RED
1	Battery charge OK, 75% to 100%, Airflow OK		✓	✓	✓	
2	Battery charge OK, 50% to 75%, Airflow OK			✓	✓	
3	Battery charge OK, 25% to 50%, Airflow OK				✓	
4	Battery charge LOW, 0% to 25%, Airflow OK					✓
5	Airflow LOW, Battery charge LOW	✓				✓
6	Airflow LOW, Battery charge OK, 75% to 100%	✓	✓	✓	✓	
7	Airflow LOW, Battery charge OK, 50% to 75%	✓		✓	✓	
8	Airflow LOW, Battery charge OK, 0% to 50%	✓			✓	

- When all three Green LEDs are lit, the Battery has approximately 75% to 100% of its charge.
- When two Green LEDs are lit, the Battery has approximately 50% to 75% of its charge.
- When only one Green LED is lit, the Battery has approximately 25% to 50% of its charge. When this occurs the user should prepare to exit to a safe area to obtain a fully charged Battery.
- When all three Green LEDs are off and the Red LED is lit, the Battery level is low, with approximately 0% to 25% charge left. When this occurs the user should promptly exit to a safe area to obtain a fully charged Battery.
- If the Battery did not provide 8-10 hours of use, change to a fully charged Battery or recharge the current Battery. (The optional 2500-37TSC Battery can provide as much as 12-15 hours of use per charge).

4 Front snaps for Liner - Front mounting of Liner to Helmet

5 Front Headband Comfort Strip - Provides cushion for comfort. Attached via Velcro, and removable. For assembly/disassembly refer to Sections 11.

6 Front Liner Pads - Provide cushion for comfort. Attached via adhesive. For replacement refer to the 2000-206 User Instructions at www.maxair-systems.com>SUPPORT>USER INSTRUCTION MANUALS.

7 Side Adapters - For assembly of Hoods

8 Side Tabs - Part of air sealing system.

9 Side Adjustment Straps with Snaps - Height adjustment. Four holes represent four possible height adjustments to accommodate different head sizes and ensure convenient viewing of the LED Safety Status Indicators. Secure into desired position by snapping against post/stud. Both sides are to be in the same hole position.

10 Rear Liner Pads - Provide cushion for comfort. Attached via adhesive. For replacement refer to the 2000-206 User Instructions at www.maxair-systems.com>SUPPORT>USER INSTRUCTION MANUALS.

11 Helmet Label - PN, CATALOG NUMBER and SN identification. Refer to symbol definition chart for further details.

12 Rear snaps for Liner - For mounting Liner to Helmet

13. TurnLock Power Cord Connector - Easy and secure attachment and removal of Power Cord to/from Helmet.

14 Liner Power Cord Slot - Allows removal and attachment of Liner without removing Power Cord.

15 Airflow Controller - Allows user to select range of air flow to meet work activity and personal comfort.

 **CAUTION**
The Air Flow Switch is user adjustable to match the amount of air flow with the user's activity level and breathing requirements.

CAPR Helmets are equipped with a switch which adjusts the operating airflow. When the Helmet is first turned on it will start at a low level, then the airflow will increase to a preset point according to the switch position.

 **NOTE**
When the Helmet is initially connected to the Battery, all five LED Safety Status Indicators are lighted briefly indicating all are functional. The red and yellow LEDs will turn off and the airflow increases to the appropriate operating level based on the Air Flow Switch position. The green LEDs will be on as appropriate to the battery charge level as indicated in the LED Safety Status Indicators table (previous page).

Air Flow Switch Position		
Low	Med	High
Air Flow in Liters Per Minute		
190	215	240

 **NOTE**
The flow levels, in liters per minute, are only approximate.





16 Comfort Pad - Provides cushion for comfort and sizing for very small head sizes. Attached via Hook and Loop, and removable. For replacement refer to the 2000-209 User Instructions at www.maxair-systems.com>SUPPORT>USER INSTRUCTION MANUALS.

17 Power Cord - Battery to Helmet Connection. For replacement refer to the 2590-05 User Instructions at www.maxair-systems.com>SUPPORT>USER INSTRUCTION MANUALS.

18 Headband Ratchet Knob - Head circumference adjustment knob.

3.5.4 Helmet Symbol Definitions

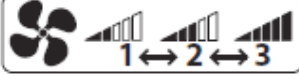
These symbols are located on the Helmet and are defined as follows:

	<p>Yellow safety LED = Low airflow, check filter and replace if necessary.</p>		<p>Use with rechargeable Li-Ion batteries only.</p>
	<p>Green safety LEDs = battery level.</p>		<p>Airflow Speed relative to position of switch.</p>
	<p>Red safety LED = low battery.</p>		<p>Do Not Use in environments requiring intrinsic safety</p>

3.6 Standard Face Cover, 2365-02SM/ML (01031291, 01031316), Overview

Identify, familiarize and understand the following key items.

1. Side Attachment Holes

2. Front Attachment Hole

3. Flappers

4. Lens

5. Cuff

6. Peel Tab attached to Lens protective liner

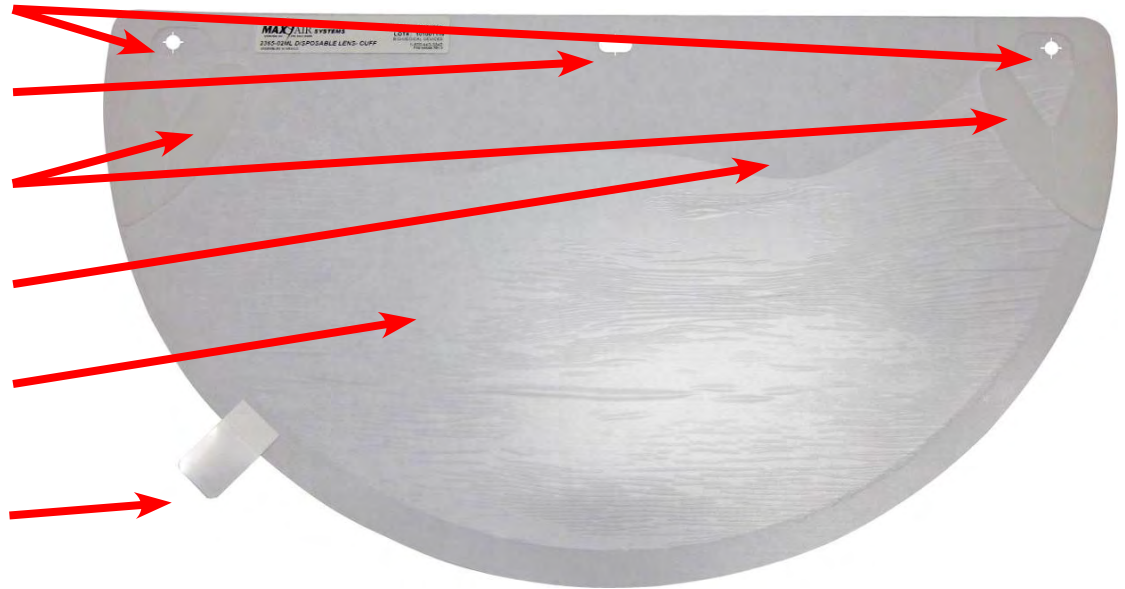

#	Characteristics
1	Mounts to the FCC Side Post Adapters.
2	Mounts to the Helmet FCC Front Post Adapter.
3	Rest against Helmet Liner Side Foam. Act as side air deflectors that channel air away from the ears.
4	Transparent for visibility. Lens is on the front, outside of the DLC.
5	Facial conforming seal, from one temple, down under the chin, and up to other temple. Cuff is on the back, inside of the DLC.
6	To facilitate Len's protective liner removal.

3.7 Battery, Belt, and Charger Overview

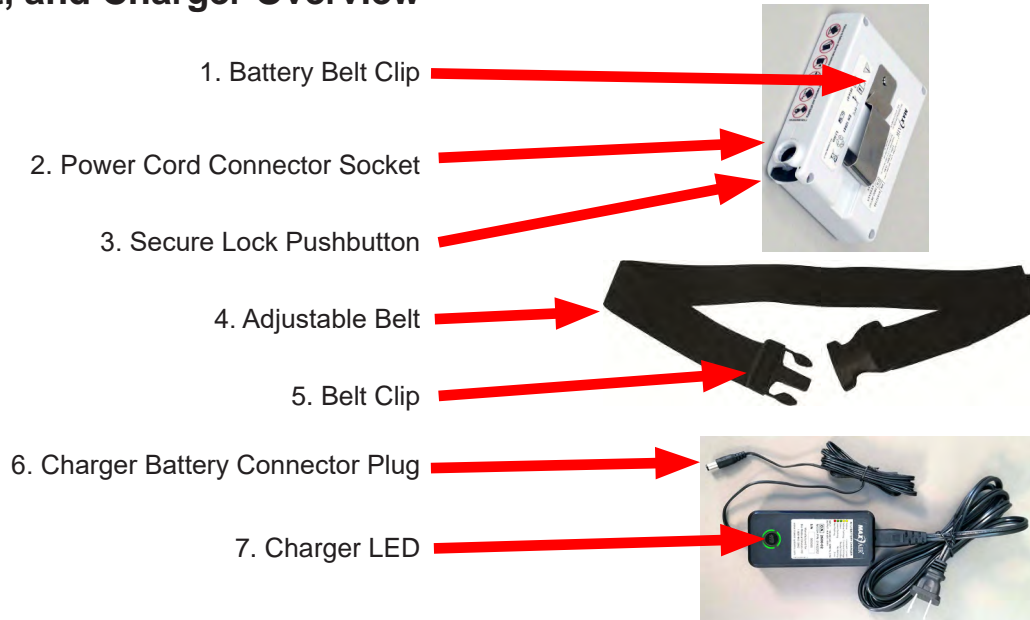

#	Characteristics
1	Attaches to Adjustable Belt or clothing
2	Socket for Helmet's Power Cord or Charger's Battery Plug.
3	Releases the Power Cord Connector for removal
4	Wraps around waist. Battery is attached to belt via the belt clip.
5	Secures belt to the waist.
6	Charging status indicator for Li-Ion Battery. Yellow, Flashing Yellow = Charging Green= Charge Complete
7	Plugs into Li-Ion Battery socket.

Battery and Charger Symbol Definitions

These symbols are located on the device and are defined as follows

Battery

	Rechargeable. For use only with MAXAIR Li-Ion Batteries		Do not attempt to disassemble, open, or service.
	Do not place near or in a flame.		Do not drop.
	Do not immerse in liquid.		Do not puncture.

Charger

	Charger's Green LED light, Charge Completed.		Charger's Yellow LED light, Charging
--	---	--	---

4. Decontamination / Cleaning



CAUTION

- Do not immerse the battery, helmet and fan module into water or other liquid. This will cause irreparable damage to the helmet.
- Do not use solvent or alcohol to clean the helmet. Isopropyl alcohol may be used to clean the Helmet. However, repeated long term use of isopropyl alcohol may deface the Helmet.
- Do not subject helmet to any sterilization cycles.
- Do not use organic solvents or strong oxidizing agents to clean the helmet.
- The air channels should never need cleaning. If they do, the Filters are not being maintained properly or replaced at the appropriate intervals.
- If other cleaning agents are to be used, it is recommended to test their use on a small section of one DLC Lens and/ or a small section of the Helmet Liner to determine short and long term side effects.
- It is not recommended to disconnect the Power Cord from the Helmet. The Power Cord should be decontaminated and cleaned as part of the Helmet.

Decontaminating

Supplies Needed:	Frequency:	Accomplishes:
<ul style="list-style-type: none"> • Decontaminating wipe • Decontaminating Agent: Alcohol wipes. 	<ul style="list-style-type: none"> • Wipe between uses and between different users wearing the system. 	<ul style="list-style-type: none"> • Reduces cross contamination. • Extends useful life. • Improves hygiene.
Procedure:		
1. Inspect the system and perform any assembly/disassembly instructions necessary for disposable items and for all components that have become worn or damaged.	2. Apply a suitable wipe with a decontaminating agent over all outside reachable surfaces, and then over all inside surfaces.	3. Let air dry and re-assemble or place in storage.



NOTE

- If desired, replace the DLC, Helmet Liner, Filter Cartridge, or Filter Cover Cap by following their assembly and disassembly procedures.
- Replace the Front Headband Comfort Strip with a new one.
- The rear Closed Cell Foam comfort pad may be cleaned for reuse by wiping down the outer surfaces with a decontaminating wipe.

Cleaning

Supplies Needed:	Frequency:	Accomplishes:
<ul style="list-style-type: none"> • Clean Damp Cloth • Cleaning Agent: Mild application of skin friendly soap. 	<ul style="list-style-type: none"> • Wipe between uses and between different users wearing the system. 	<ul style="list-style-type: none"> • Reduces cross contamination. • Extends useful life. • Improves hygiene.
Procedure:		
1. Use a damp cloth with cleaning agent to clean all outer and inner exposed surfaces.	2. Let air dry.	



NOTE

- If desirable, replace the damaged or soiled Front Headband Comfort Strip.
- The rear Closed Cell Foam comfort strip may be cleaned for reuse.

5. General System Maintenance and Storage



CAUTION

Prior to each use, if any of the following issues are discovered for any system component(s), replace the particular item(s) by following the assembly/disassembly procedures for the particular item(s).

- Tears or Breaks.
- Contamination from blood or other bodily fluids not safely removed by following approved disinfection procedures.
- Compromise between the DLC and FCC seal.
- Damage or distortion to the filter cartridge gasket.
- Filter is soiled or challenged with particulates such as to compromise its performance or cause the yellow LED to be lighted.
- Compromise between the filter cartridge and helmet seal.
- Any other damage and threat to proper function.



NOTE

The complete MAXAIR CAPR System and all components and accessories should be stored indoors in a safe, clean and secure environment at all times, protected from adverse environmental conditions, i.e. conditions that would be considered incompatible with normal human working conditions without special equipment.

General System and Component Storage Environment

Temperature/ Humidity

Temperature: 0° C to +35° C

Maximum Humidity: 80% Relative Humidity.

Helmet Liner

- If the Helmet Liner is loosened after repeated assembly/disassembly so as to compromise its attachment mechanism or causes the Helmet mounting to be unstable and if there are any tears or breaks in the Liner, the Helmet Liner should be replaced by following its assembly and disassembly procedure.
- The Liner Power Cord Slot allows removal and attachment of the Liner without removal of the Power Cord.

Helmet

- If the Helmet is damaged or operating improperly, do not attempt repair. Contact Customer Service, 1-800-443-3842 for the return procedure for evaluation and possible repair or replacement.

Helmet Power Cord

- If the Helmet Power Cord connectors and cord insulation appear damaged in any manner, and if any cord wire is exposed, replace with a cord in good working condition. Grasp the cord connector firmly and turn it until its notch is aligned with the Helmet cord connector slot, then pull the cord connector straight up and away from the helmet. Replace with a new cord by aligning the Cord connector notch with the Helmet connector slot, insert the Cord connector into the Helmet connector, and turn the Cord towards the rear of the Helmet to secure it in place.

Filter Cartridge

- If the Filter is soiled or loaded (clogged) with particulate such as to compromise its performance or cause the Yellow LED to be lighted, or if there are tears or breaks, or if there are compromises between the seal and the Helmet, or any other damage, the Filter Cartridge should be replaced by following the assembly and disassembly procedures for the FCC and the Filter Cartridge.

- Particular attention must be made to inspection of the Filter Cartridge (black) Gasket for any damage that could adversely affect its seal with the Helmet. If there is any damage or doubt regarding the seal, replace the Filter Cartridge.

Filter Cover Cap (FCC)

- The FCC must be inspected before each use. If the FCC is loosened after repeated assembly/disassembly such as to compromise its attachment mechanism or causes the Helmet mounting to be unstable, or if it has tears or breaks, the FCC should be replaced by following its assembly and disassembly procedures.

Disposable Face and Head Covers: DLC Cuffs, Shrouds, Double Shrouds, and Hoods

- The DLC Line of Face and Head Covers is designed for single use, once on/once off the Helmet. Repeated assembly and disassembly will compromise the attachment mechanism or cause the Helmet mounting to be unstable. The DLC items should be discarded as contaminated waste after removal from the system and replaced by following the appropriate item assembly and disassembly procedures in this User Instructions and the individual Instructions For Use.
- If there are any tears or breaks or fluid penetration in the DLC items, or any issues with the visual clarity of the Lenses, the DLC item should be replaced by following the appropriate assembly and disassembly procedures.

Battery

- MAXAIR Systems Li-Ion Batteries are designed to be maintenance free. If a battery has any damage or malfunction, contact Customer Service at 1-800-443-3842, for an RMA (Return Material Authorization) for evaluation and possible replacement.
- Also refer to the next section, Battery Use and Maintenance, for additional instructions regarding Batteries.



Do not drop



Do not puncture.



Do not immerse in liquid.



Do not attempt to disassemble, open, or service.



Do not place near or in a flame.

Battery Charger

- MAXAIR Systems Battery Chargers are designed to be maintenance free. If a charger has any damage or malfunction, contact Customer Service at 1-800-443-3842, for an RMA (Return Material Authorization) for evaluation and possible replacement.



Do not drop



Do not puncture.



Do not immerse in liquid.



Do not attempt to disassemble, open, or service.



Do not place near or in a flame.

6. Battery Use, Maintenance and Storage



CAUTION

Do not store batteries for more than three months without subjecting them to normal discharge and recharge cycling. Ideally, batteries not being used routinely on a less than monthly frequency should be charge-cycled every three months, minimum.
Optimal storage for Lithium Ion batteries is at 50% charge and approximately 0°C-10°C.



CAUTION

MAXAIR Systems Lithium Ion (Li-Ion) batteries (LIBs) are secondary (rechargeable) batteries, not primary (storage) batteries.

MAXAIR Systems Li-Ion Batteries (LIBs) hold much of their charge for a year or longer. However, as with all rechargeable batteries, the amount of charge will decline slowly in use or storage (*self-discharge rate*), depending on time and temperature, and the maximum *recoverable charge* level diminishes gradually over the life of the battery.

6.1 Routine Infection Control use in med/surg and ED areas

- If LIBs are being used more than once per month, they should be connected to chargers in between uses.
- Before each use, physically inspect the LIB. If you perceive physical damage or tampering, use a different MAXAIR LIB and replace the damaged LIB as soon as possible.
- Routinely, every 3-6 months, perform the “LIB Check Procedure” (see Section 6.3.7). If this procedure results in a “Suspect LIB”, use a different MAXAIR LIB and replace the Suspect LIB as soon as possible.
- Check LIBs that are connected to MAXAIR chargers on a daily basis. If the charger LED is green, the LIB is ready for use and should be disconnected from the charger.



CAUTION

Check LIBs connected to chargers on a daily basis.

If a LIB is warm-to-hot to the touch, disconnect the LIB from the charger and replace it immediately. If this condition is ever observed, please mark the specific battery and the specific charger it was connected to when the heating was noted, and contact us for replacement. Call Customer Service, 1-800-443-3842, for return and replacement instructions.

If the charger LED is Green, the LIB is fully charged and ready for use, therefore disconnect if from the charger. DO NOT leave the LIBs on the chargers after the charger LED turns Green.

6.2 Emergency Preparedness (EP) and In-Frequent Use

- MAXAIR batteries are shipped to customers at the 50% charge level (approximately 14.6v output level). This is the approximate level recommended for long term storage of a Li-Ion batteries, and therefore what we recommend for EP use to achieve the longest overall useful life of the batteries.
 - For a new 2500-30TSC battery this represents up to 8 hours of use before recharging to a fully charged level.
 - For a new 2500-37TSC battery this represents up to 6 hours of use before recharging to a fully charged level.
 - For a new 2500-36TSC battery this represents up to 4 hours of use before recharging to a fully charged level
- For systems that may be in storage and not used for longer than a year, the battery charge should be revalidated every 3-6 months, minimum.

6.3 General Use, Maintenance, and Storage



WARNING

Failure to read and follow these instructions and guidelines may result in fire, personal injury and damage to property. Your MAXAIR LIBs need to be handled/transported, used/discharged, charged, and stored properly. Follow the safety rules listed below.

Follow these instructions and the Belt Mounted Batteries User Instructions at www.maxair-systems.com>SUPPORT>USER INSTRUCTION MANUALS, and use MAXAIR LIBs in accordance to the warning labels on the MAXAIR LIBs to properly manage and control charging and discharging of all MAXAIR LIBs.

1. Keep MAXAIR LIBs and Chargers away from children.
2. Test MAXAIR LIBs before using to ensure they are operating properly and safely with the MAXAIR Helmet or on the MAXAIR Charger. (see Section 6.3.7).
3. As with all Li-Ion battery packs, misused and defective Li-Ion cells may explode and cause fire. If at any time a LIB starts to balloon, swell up, smoke or get hot, emit an unusual smell, change color, or appear abnormal in any other way, discontinue its use immediately, disconnect the LIB from the Helmet or Charger, and observe it in a safe place for approximately 15 minutes. If any of these conditions occur, the LIB should be replaced.



CAUTION

These conditions may result in LIB cell leakage. Since delayed chemical reaction can occur, it is best to observe the LIB as a safety precaution in a safe area outside of any building or vehicle and away from any combustible material. In the event of coming in contact with any leakage from a LIB, do not rub or touch the eyes, immediately rinse all contacted areas thoroughly with water, and immediately seek medical care. If left untreated, the LIB leakage could cause eye and other serious injury.

4. In the event of any damage or perceived damage to a LIB due to bad shipment or other reason, remove the LIB to a safe location for observation and place it in a safe open area away from any combustible material for approximately 15 minutes.
5. Do not place LIBs in direct sunshine, or use or store LIBs inside relatively closed environments (cars, etc.) in hot weather and anywhere extreme temperatures may exist. Doing so may cause the LIB to generate heat, rupture, or ignite. Using the LIB in this manner may also result in a loss of performance and a shortened life expectancy.
6. Do not use, charge or store LIBs in or near microwave ovens, high pressure containers, or conduction cookware.
7. Do not expose a LIB to water, salt water, any other liquid, or moisture, beyond air with a relative humidity between 10%-90%.
8. Do not connect the connection terminals together, even momentarily, with any material including touching with the human body.
9. Do not allow a LIB to make contact with a hard object (dropping, throwing, striking, piercing, etc.) so as to subject it to strong impact, shock, or other mechanical stress.
10. Do not open, penetrate, or attempt to disassemble or modify a LIB case in any manner without contacting the manufacturer. The LIB contains safety and protection devices which, if damaged, may cause the LIB to generate heat, rupture, or ignite.
11. Do not submit to static electricity.

6.3.1 Recommended Temperature Ranges

Degrees Centigrade		Degrees Fahrenheit		Activity
min.	max.	min.	max.	
0	54	32	129	Handling & Transporting
0	54	32	129	Use/Discharging
0	45	32	113	Charging
0	35	32	95	Storage

If recommended temperature range is exceeded, let batteries cool down or warm up, as appropriate,

to ambient temperature, and ensure all condensation, if any, has evaporated before charging or use.

6.3.2 Use/Discharge



WARNING

Do not discharge a LIB by using any device except a MAXAIR Helmet.

The temperature range over which a LIB is to be discharged is 0° C-54° C (32° F-129° F). Use outside of this temperature range may damage the performance and reduce the life expectancy of the LIB.



CAUTION

When the LIB has reached its usual and customary useful life (See 6.3.6) -

Immediately discontinue use of the LIB and replace it.

Insulate the connection terminals with adhesive tape or similar material before disposal.

6.3.3 Charge



WARNING

Always use a MAXAIR charger when charging a LIB; never use any other type of charger for a MAXAIR LIB.

Never connect a LIB to any device other than a MAXAIR helmet or a MAXAIR charger.

Never charge a LIB outside the temperature range of 0° C to 45° C (32° F to 113° F). Charging the LIB at temperatures outside of this range may cause the battery to become hot or damaged. Charging the LIB outside of this temperature range may also harm the performance of the LIB or reduce the LIBs life expectancy. When the LIB becomes hot, the built-in safety equipment is activated, preventing charging further. Additional heating can destroy the safety equipment and can cause accelerated temperature increases, ignition, or other damage to the LIB.

Do not continue charging the LIB if it does not recharge within the maximum charging time (See 6.3.8) Doing so may cause the LIB to become hot, rupture, or ignite.

Always charge in an isolated area, away from flammable materials.

When charging LIBs, always monitor the charging process and react to potential problems that may occur.

6.3.4 Store



WARNING

Store in closed containers and packaging that prevent short circuits and damage during storage or transportation.

In case of mixed storage of goods and articles, organize separate storage areas for LIBs, for example, by maintaining a distance of 2.5 meters between the LIB storage area and other goods.

Store in limited quantities and in isolated area with frequent surveillance.

Keep in a dry, cool and well-ventilated place, within the recommended storage temperature range of

0° C-35° C (32° F-95° F). Cooler and dryer environments of storage are safer and extend useful life.

The temperature range of 19° C-25° C (66° F-77° F) at 30%-50% full charge will optimize battery useful life.

Perform a charge and LIB Check Procedure (6.3.7) every 3 to 6 months; this will help prevent the potential of an over-discharge.

6.3.5 Handling and Transport

Lithium-Ion batteries are classified as Dangerous Goods for the Transport by Road/Rail, Sea and Air. When considering transporting LIBs to other locations, conform to the requirements of the UN Regulation on the Transport of Dangerous Goods.

Internal transfer of Lithium-Ion batteries should follow the minimum safety rules imposed by the local legislation/regulation regarding the handling of Dangerous Goods.

When handling LIBs, use caution, specifically to avoid shorting the connector terminals.



WARNING

Do not exceed the temperature range of 0° C-54° C (32° F-129° F) when handling and transporting LIBs.

Do not expose battery packs to direct sunlight and/or heat for extended periods.

6.3.6 Useful Life

Li-Ion batteries begin aging when they are manufactured - not when you begin using the battery. Lithium-Ion batteries are prone to aging somewhat rapidly. The useful capacity (Recoverable Capacity) of a Lithium-Ion battery decreases about 10% to 20% each year. Therefore, Lithium-Ion batteries have a useful aging-service life of approximately four years.

Li-Ion batteries have a useful capacity-service life of 300-500 cycles (one cycle being the time of one full use from a full charge).

Therefore, the recommended useful life expectancy, or replacement schedule, for a Li-Ion battery is after four years or 300-500 discharge cycles, whichever occurs first.

6.3.7 LIB Check Procedure - MAXAIR LIB Test for Diminishing Battery Capacity



NOTE

A MAXAIR helmet and MAXAIR charger are required to perform this basic battery test. The helmet and power cord must be in good working order. Set the helmet Air Flow Switch to Low for the test.



CAUTION

If the LIB performs in one of the "Suspect LIB" categories below, discontinue using it and replace that LIB as soon as possible.

Case 1: The LIB has been connected to a charger and the charger green LED is on.

Procedure: Unplug the LIB from the charger and plug the helmet power cord to the LIB. Allow the helmet to settle for about 10 seconds.

Good LIB: The helmet runs with 3 or 2 green indicator lights on.

Suspect LIB: The helmet runs with only 1 green indicator light on.

Suspect LIB: The helmet runs with the red indicator light on.

Suspect LIB: The helmet doesn't run.

Case 2: The LIB has been in storage.

Procedure: Plug the helmet power cord to the LIB to be tested. Allow the helmet to settle for about 10 seconds.

Good LIB: The helmet runs with 3, 2 or 1 green indicator light on.

Suspect LIB: The helmet runs with the red indicator light on.

Suspect LIB: The helmet doesn't run.

Case 3: The LIB is connected to the MAXAIR Charger.

Good LIB: the LIB is felt to be about room temperature.

Suspect LIB: the LIB is warm or hot to the touch.



6.3.8 Reference Information

Typical Charging Time Specifications:

Time to fully charge a fully discharged MAXAIR LIB

CHARGING TIME		
BATTERY	2600-01 (01432089) Charger	
	Typical	Maximum
2500-30TSC (01532116)	5 hrs	10 hrs
2500-37TSC (01532161)	3.8 hrs	7.5 hrs
2500-36TSC (01532104)	2.5 hrs	5.0 hrs

Lithium-ion Battery main components:

SDS for Li-Ion Battery Cells are available under Safety Data Sheets at www.maxair-systems.com>SUPPORT>PRODUCT LITERATURE.

6.3.9 Charging Protection from Electrical Surges

It is highly recommended to always connect the MAXAIR Charger directly to a Surge Protection Device, adequate for all anticipatable occurrences, during all charging activities of MAXAIR LIBs, and whenever the Charger is connected to a mains power source.

To choose an appropriate surge protector you should consult with your Engineering department regarding specifics to your physical plant and geographical environment. You may want to consider the following common fundamentals of surge protection:

To choose an appropriate surge protector you should consult with your Engineering department regarding specifics to your physical plant and geographical environment. You may want to consider the following common fundamentals -

- ▲ Indicator light – surge protectors will not last forever – when a surge protector properly diverts a surge, the protector itself can be damaged in the process. An indicator light will indicate that the surge protector is working fine.
- ▲ UL Rating - good surge protectors come with a UL rating (or equivalent regulatory mark for non U.S. countries, e.g. CE Mark, etc.), a rating put out by the independent Underwriters Laboratories that tests the safety of electronic devices.
- ▲ Clamping voltage - the voltage measurement that prompts the surge protector to start redirecting the excess electricity away from the plugged-in devices.
- ▲ A surge protector with a lower clamping voltage will trigger earlier, thus better protecting electrical devices.
- ▲ Joule rating - the maximum amount of energy the surge protector can absorb. If the surge exceeds this maximum, the surge protector will be rendered useless. The higher the joule rating, the more energy can be absorbed by the surge protector, therefore, a higher joule rating will often indicate a longer lifespan for the product.

6.3.10 Projected LIB Level Available As A % At Initial Manufacture Versus Temperature

Year(s) Elapsed from Manufacture Date	Storage Condition: 50% charged				Storage Condition: 100% charged			
	Residual Capacity (due to Self- Discharge)		Recoverable Capacity		Residual Capacity (due to Self- Discharge)		Recoverable Capacity	
	23°C	60°C	23°C	60°C	23°C	60°C	23°C	60°C
1	96%	76%	99%	92%	90%	60%	94%	80%
2	92%	52%	98%	84%	80%	20%	88%	60%
3	88%	28%	97%	76%	70%	0%	82%	40%
4	84%	4%	96%	68%	60%	0%	76%	20%
5	80%	0%	95%	60%	50%	0%	70%	0%
Year(s) Elapsed from Manufacture Date	Self-Discharge Loss		Permanent Capacity Loss		Self-Discharge Loss		Permanent Capacity Loss	
	23°C	60°C	23°C	60°C	23°C	60°C	23°C	60°C
1	4%	24%	1%	8%	10%	40%	6%	20%
2	8%	48%	2%	16%	20%	80%	12%	40%
3	12%	72%	3%	24%	30%	100%	18%	60%
4	16%	96%	4%	32%	40%	100%	24%	80%
5	20%	100%	5%	40%	50%	100%	30%	100%

6.3.11 Glossary

LIB

Lithium Ion Battery, Li-Ion Battery

Self Discharge

The rate at which the battery charge level declines while it is just sitting in storage, usually quoted as a decline in %-per-month.

Self-discharge increases with age, cycling and elevated temperature.

Discard a battery if the self-discharge reaches 30 percent in 24 hours.

Recoverable Capacity

The amount that a battery can be “fully charged back to” over time, usually quoted as a certain % of the full charge level when the battery was initially manufactured.

7. Disposal



WARNING

Dispose of potentially contaminated disposable components, DLCs, DLC-Shrouds, DLC-Hoods, Filter Cartridges, etc., in accordance with approved institutional protocol for medical waste and current local regulations.



Lithium-Ion Rechargeable Batteries contain toxic chemicals and must be disposed of following current local regulations, and your local recycling program. Additional information may be found at earth911.com and ecyclingcentral.com.



Helmets and Battery Chargers contain electronic components and must be disposed of following current local regulations, and your local recycling program. Additional information may be found at earth911.com and ecyclingcentral.com.



8. Unpacking Standard System Configuration Components and Parts Identification

8.1 Unpacking the 2081-03 (03531001, 03531021, 01031269, 2590-05)CAPR Helmet

Carefully unpack the 2081-03 MAXAIR CAPR Helmet from the shipping box. Verify there are no missing or loose components and that the helmet shows no signs of physical damage. Assemble the Helmet into the desired configuration and verify that it is fully functional. Report any damage to the shipper immediately for resolution. (Follow similar procedure for all MAXAIR Helmets.)

Contact Customer service 1-800-443-3842, if you have questions.

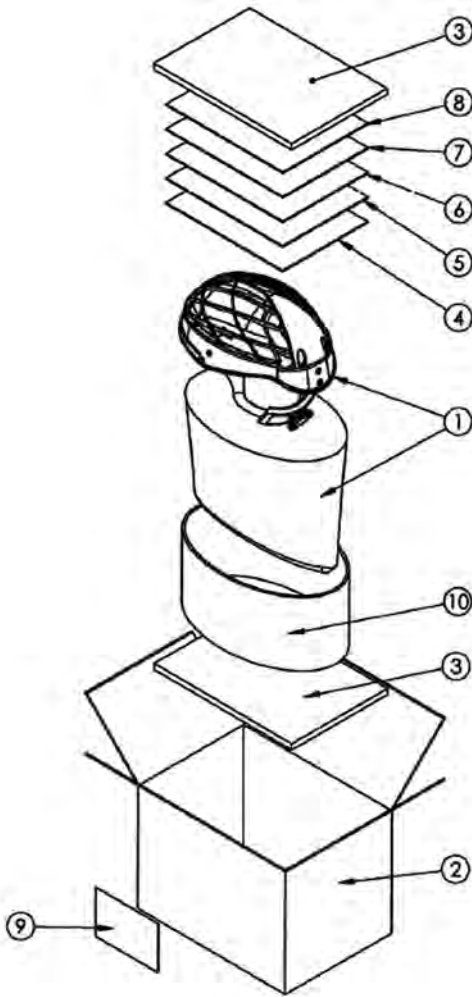

ITEM	PART NO	DESCRIPTION
1	2081-03	Helmet Assembly
2	03521053	Shipping Box
3	03523060	Foam Pad
4	03531132	NIOSH Approved Label
5	00723154	Registration - Warranty Sheet
6	03523168	Quick Set-Up Guide
7	03521015	UIM - Users Instructions
8	03521080	Symbol Definition Chart
9	03533203	Box Label
10	03523054	Single Face Corrugated Pad

8.2 Unpacking the 2500-36TSC (01532104) Battery

Carefully unpack the 2500-36TSC Battery from the shipping box. Verify there are no missing or loose components and that the Battery show no signs of physical damage. Connect the Battery to a fully assembled CAPR Helmet with Filter Cartridge and Filter Cover Cap or Hood to verify that it powers the Helmet and that at least one Green LED lights. Report any damage or non-function to the shipper immediately for resolution. (Follow similar procedure for alternate MAXAIR Batteries.)

Contact Customer service 1-800-443-3842, if you have questions.

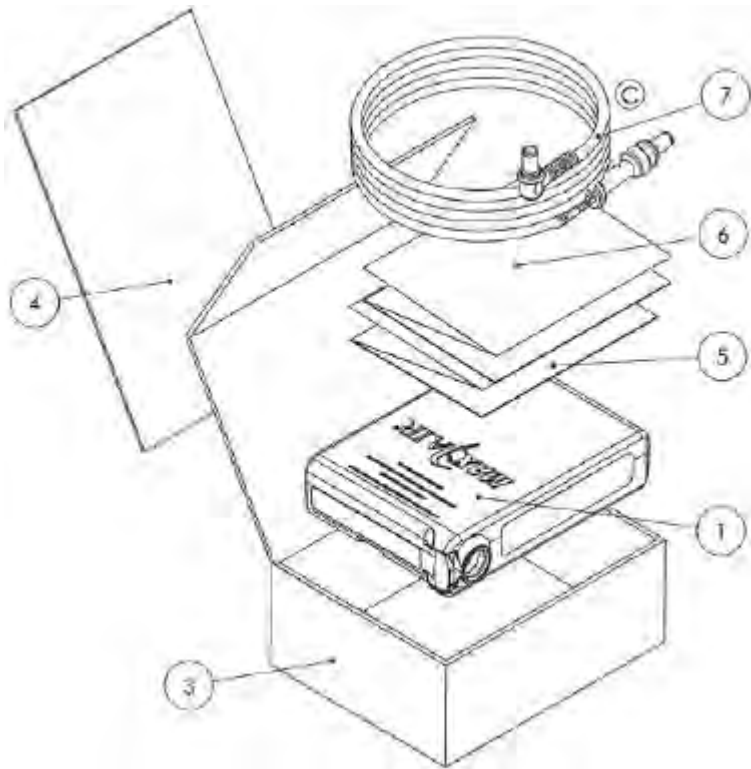

ITEM	PART NO	DESCRIPTION
1	2500-36TSC	Li-Ion Battery
2	00011340	Bubble Wrap
3	02523090	Box
4	01523115	Box Label
5	01523128	IFU - Instructions for Use
6	03521080	Symbol Definition Chart
7	2590-05	Power Cord

8.3 Unpacking the 2000-76 Battery Belt

Carefully unpack the 2000-76 Battery Belt from the shipping bag. Verify there are no missing or loose components and that the Belt shows no signs of physical damage. Report any damage or non-function to the shipper immediately for resolution.

Contact Customer service 1-800-443-3842, if you have questions.

Part List					
Item	Dwg. No.	Dwg. Title	Material	Fit/Function	QTY.
1	2000-76	Lithium-Ion Battery Belt Assembly	N/A	Battery Holder	1
2	00721160	Dual Body	Polyacetal	-	1
3	00721143	Belt, Latch	Polyacetal	-	1
4	P940003	Plastic Webbing	Plastic	-	76 1/2"
5	00723150	Label, Part Number	Label/Adhesive	Informative, Part Number Location	1
6	00721144	Belt Holder	Polyacetal	Belt Holder	1

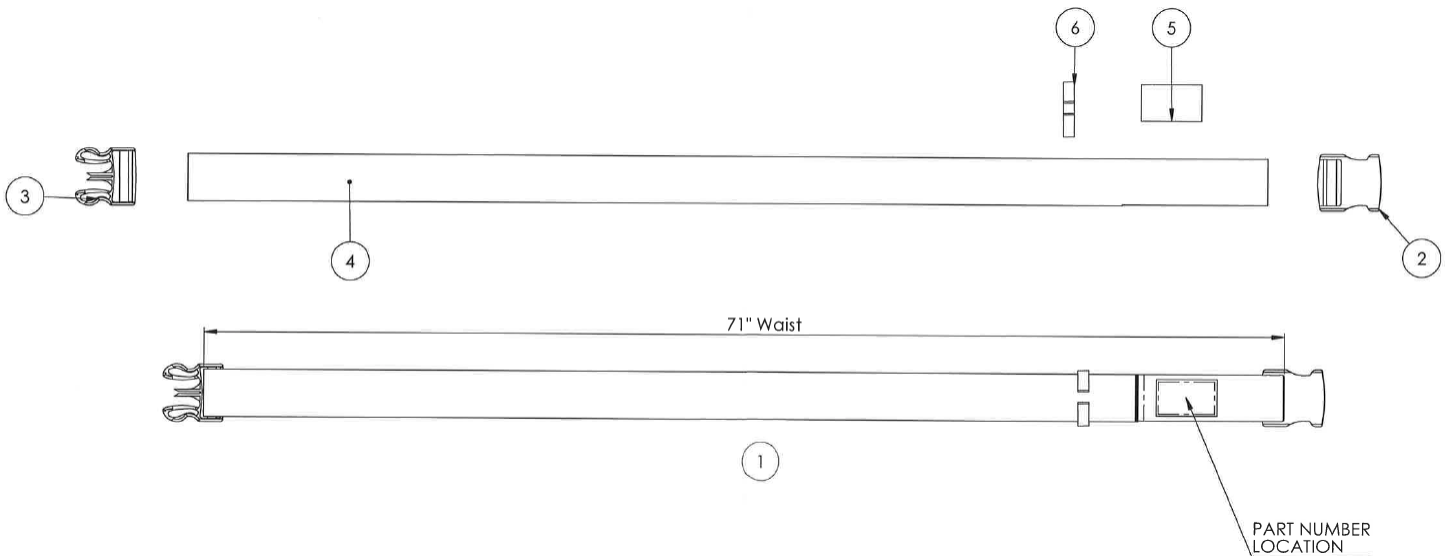

8.4 Unpacking the 2600-02 (01432202) Battery Charger

Carefully unpack the 2600-02 Battery Charger from the shipping box. Verify there are no missing or loose components and that the Charger shows no signs of physical damage. Connect the Charger to a working wall outlet and verify that the Green LED is lit. Connect the Charger to a Battery that powers a MAXAIR Helmet with either a red LED or one or two Green LEDs lit, and verify that when that Battery is connected to the Charger, the Charger LED turns from Green to Red to indicate that it is charging the Battery. Report any damage or non-function to the shipper immediately for resolution. (Follow similar procedure for alternate MAXAIR Chargers.)

Contact Customer service 1-800-443-3842, if you have questions.

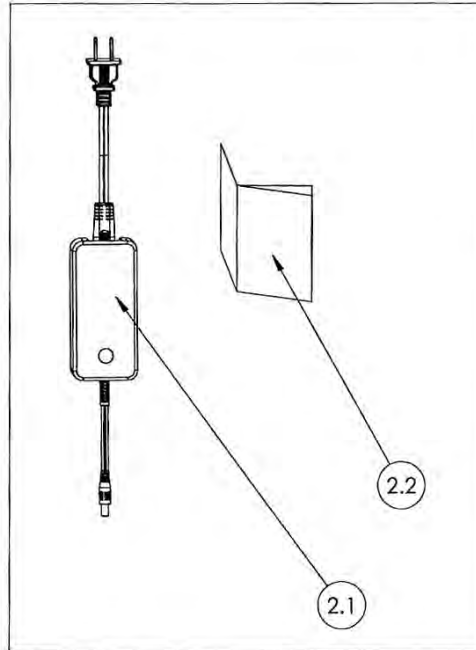

1. PART LIST		
Item #	P/N	Description
1	P900127	Box, Shipping
2	01432206	Charger
2.1	01432202	Charger (NIOSH)
2.2	01423205	Product Specification Sheet
3	01433207	Label, shipping
4	03521080	Symbol Definition Chart

8.5 Unpacking 2365-02SM (01031316) and 2365-02ML (01031291) DLC (Disposable Lens Cuff)



Carefully inspect the DLC boxes to ensure there is no physical damage to the boxes and contents. Report any damage to the shipper immediately for resolution. (Follow similar procedure for all MAXAIR DLC Cuffs.)

Contact Customer service 1-800-443-3842, if you have questions.



NOTE

DLC Boxes are 2 sizes, Long (placed on bottom) for the larger 2365-02ML, and Short (placed on top) for the smaller 2365-02SM. Stack as shown for easy dispensing.



1. Open the dispensing end by grasping the box end with your left hand as shown and push through the top curved perforation line.



2. Pull the top-end piece off and away from the box.



3. Brace the right-side end piece with your right hand. Pull the left-side end piece along its perforation line, tearing downward.



4. Pull the left-side end piece down and off the box.



5. Lift the box a few inches with your right hand. Tear off the small bottom-end piece at its perforation line.



6. When finished, the dispensing box should be as shown above.



7. To Dispense, merely reach in and grasp the end of the top DLC and pull slightly up and out.



8. Position a SM DLC box on top of a ML DLC box as indicated above.



9. Dispensing DLCs from the top or bottom box is easy and prompt.

There are two sizes of DLCs. The ML is for most users. The SM is for those with small head sizes.

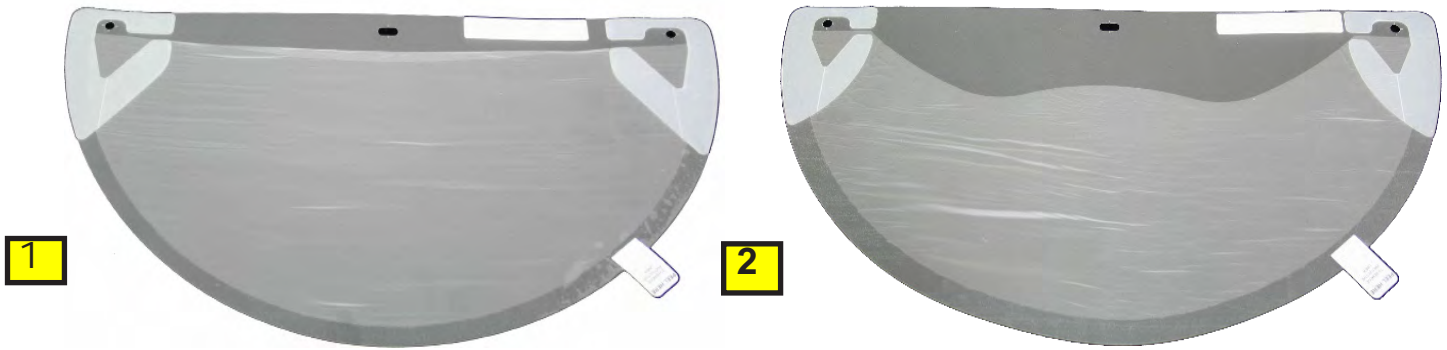

ITEM	CATALOG NUMBER	NIOSH NUMBER	QTY(EA)	DESCRIPTION
1	2365-02SM	01031316	40	DLC (Disposable Lens-Cuff) Small/Medium
2	2365-02ML	01031291	40	DLC (Disposable Lens-Cuff) Medium/Large

9. Standard System Configuration Set Up

9.1 Components Check List

Required Components				
ITEM	CATALOG NUMBER	NIOSH NUMBER	QTY	DESCRIPTION
1	2081-03	03531001, 03531021, 01031269, 2590-05	1ea	MAXAIR CAPR Helmet Assembly
2	2365-02SM or 2365-02ML	01031316 OR 01031291	40/Box	Disposable Lens Cuff (DLC) - Small/ Medium (SM) or Medium/ Large (ML)
3	2500-36TSC	01532104	1ea	Li-Ion Battery
4	2600-02	01432202	1ea	Li-Ion Battery Charger
5	2000-76	2000-76	1ea	Battery Belt
6	2167-10	01031569	1 ea	Filter Cartridge

9.2 Setting Up

1. Check the position of the Headband Comfort Strips. (See Section 7 for Comfort Strip assembly and replacement instructions).
2. Adjust the Rear Headband Ratchet Adjustment Knob counterclockwise to expand the Headband circumference to ensure the Helmet will fit easily before donning. (See Section 6 on Donning for more detail.)
3. Adjust the Height Adjustment Snaps on the Helmet Liner to ensure proper and secure fit of the CAPR System on the head and good visibility of the Safety Status Indicator LEDs. (See Section 6 for more detail.)
4. Check to ensure that the Helmet Power Cord is firmly attached to the Helmet Power Cord Connector.

9.3 Assemble and Disassemble Components



CAUTION

Prior to operation, review all components' Instructions For Use regarding set-up, assembly/disassembly, and don/doff in sections 6,10-19.

The general assembly/disassembly steps are as follows:

STEP	ASSEMBLE		STEP	DISASSEMBLE
4	Assemble the 2061-08 Filter Cover Cap to the Helmet. (Alternate Covers are appropriate for other configurations.)		2	If required, disassemble the 2061-08 Filter Cover Cap from the Helmet.
3	Snap off the 2051-07 Cage and snap on the 2167-10 Filter Cartridge from the Helmet. (Alternate Filter Cartridges may be used.)		3	If required, disassemble the 2167-10 Filter Cartridge from the Helmet. (Dispose appropriately as hazardous waste.)
1	Inspect and ready the 2081-03 Helmet for use.		5	If required, prep the 2081-03 Helmet for storage.
2	If required, assemble the 2071-08 Helmet Liner to the Helmet.		4	If required, disassemble the 2071-08 Helmet Liner to the Helmet.
5	Assemble the DLC to Helmet. (Alternate Face/Head covers may be used for other configurations.)		1	Disassemble the DLC. (Dispose of the DLC appropriately as hazardous waste.)



NOTE

If you have difficulty with the proper operation of a MAXAIR System, first check for any visible damage to the outer and inner surfaces of the helmet, and any damage to the attached helmet power cord and the battery.

Prior to each use, if any of the following issues are discovered for any system component(s), replace the particular item(s) by following the assembly/disassembly procedures for the particular item(s).

- Tears or Breaks.
- Contamination from blood or other bodily fluids not safely removed by following approved disinfection procedures.
- Compromise between the DLC (or alternate face seal) and FCC (or helmet) seal.
- Damage or distortion to the filter cartridge gasket.
- Filter is soiled or loaded (clogged) with particulate such as to compromise its performance or cause the yellow LED to be lighted.
- Compromise between the filter cartridge and helmet seal.
- Any other threat to proper function.

MAXAIR Systems are very reliable, essentially sealed helmet systems that do not require periodic maintenance. With careful and recommended use and adherence to all cautions, all components are expected to provide reliable service for their full useful life.

9.5 Warning Device: Yellow LED Air Flow Indicator Check - Bouffant Cap Method



CAUTION

Prior to donning the system, the Safety Status Yellow LED function can and should be checked prior to use. The yellow LED indicates that the respirator is no longer able to maintain adequate airflow for protection of the user



CAUTION

-
- In preparation for the following test,
1. Ensure the Bouffant Cap is in good condition with no holes or tears.
 2. For Systems to be configured with a Cuff, Shroud, or Double Shroud, ready the Helmet for test with a Filter Cartridge and Filter Cover Cap attached, and without any Cuff, Shroud, or Double Shroud attached, sections indicated as “a” in the following test.
 3. Alternately, for Systems to be configured with a Hood, ready the Helmet for test with a Filter Cartridge and Hood attached, sections indicated as “b” in the following test.



1a. Place the Bouffant Cap over the Helmet, all the way around, from top to bottom.



1b. Place the Bouffant Cap over the Hood, all the way around, from top to bottom of the Filter. Close all gaps between Bouffant Cap and Filter.



2. Connect the Helmet Power Cord to the Battery. Push the Power Cord Connector into the Battery Receptacle until the Secure Connection audibly clicks.



3. Allow the Helmet to compensate until the Yellow LED turns on (about 45 seconds with Air Flow set to High, about 90 seconds with Air Flow set to Low).

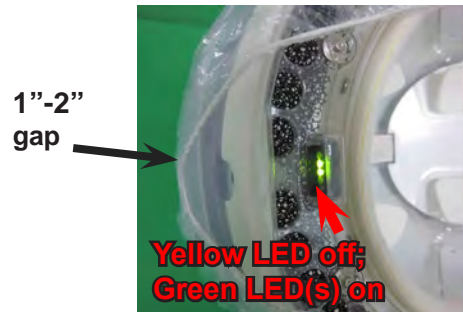

4a. As soon as the Yellow LED turns on - **in less than five seconds** - open the Bouffant Cap approximately 1" to 2" (3cm to 5cm). Notice the Yellow LED turns off. Close the Bouffant Cap gap.



4b. As soon as the Yellow LED turns on - **in less than five seconds** - open the Bouffant Cap approximately 4" to 5" (10cm to 12cm). Notice the Yellow LED turns off. Close the gap of Bouffant Cap.



NOTE

Do not allow more than ten seconds to pass before performing this step.

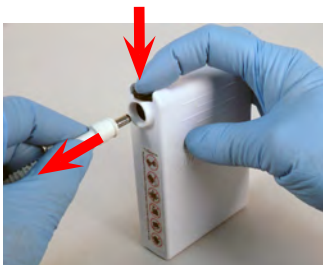

5. Disconnect the Helmet Power Cord from the Battery - push the Secure Connection Button down, pull Cord Connector out, release the Button.



6a. Remove the Bouffant Cap from the Helmet.

This concludes the test.



6b. Remove the Bouffant Cap covering the Hood.

This concludes the test.



CAUTION

Ensure the Power Cord is disconnected from the battery before performing step 6.

9.6 Warning Device: Yellow LED Air Flow Indicator Check - Tape Method



CAUTION

Prior to donning the system, the Safety Status Yellow LED function can and should be checked prior to use. The yellow LED indicates that the respirator is no longer able to maintain adequate airflow for protection of the user

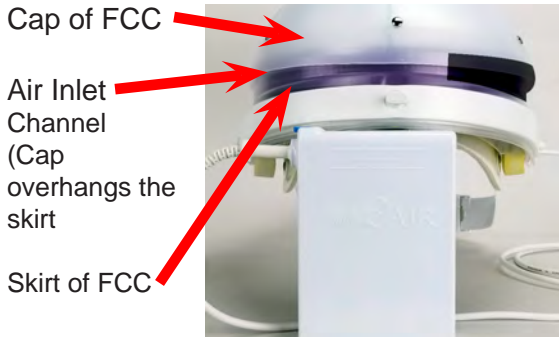

1. Start taping approximately one inch away from the front-center of the Helmet. (One inch to the side of the front Alignment post.

2. Tape over the Air Inlet Channel all the way around the Filter Cover Cap (FCC).

3. Cut the tape so that it stops in the front-center of the Helmet. This leaves about a one inch open gap.



4. Pull back a tape flap about one inch from the front-center of the Helmet, leaving about a two inch open gap.



5. Connect the Helmet Power Cord to the Battery. Push the Power Cord Connector into the Battery Receptacle until the Secure Connection audibly clicks.



6. Allow the Helmet to stabilize for about a minute. Notice that the Yellow LED stays off.



7. Lay the tape flap back down to reduce the gap back to a one inch opening. Allow the Helmet to stabilize for about a minute. Notice the Yellow LED turns on.

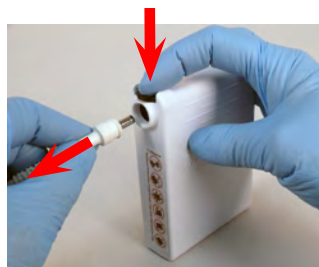

8. Disconnect the Helmet Power Cord from the Battery - push the Secure Connection Button down, pull Cord Connector out, release the Button.



9. Remove the tape covering the air inlet channel of the Filter Cover Cap.



CAUTION

Ensure the Power Cord is disconnected from the Battery before performing step 9.

This concludes the test.

10. Standard System Configuration Assembly, Donning, and Doffing



CAUTION

If there is any question about the disinfection status of the CAPR System due to a previous use, it is recommended to disinfect it before using.

This section describes assembly, donning, and doffing the Standard DLC Cuff System. The majority of procedures in are applicable to all other face/head covers, particularly with regards to battery, charger, helmet adjustments, and facial fit. Differences for other configurations are covered in the respective sections for those other face and head covers.

Assemble and Don the Battery and Belt



1. Obtain a fully charged battery. (Charger LED should be green after battery is connected to charger for more than 10 seconds.)

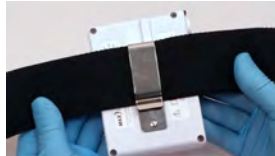

2. Assemble the battery onto the belt. Place the top edge of the Belt under the Battery Clip. Move the Belt fully under the Clip such that the Clip Detent touches the clip base, metal-to-metal.



3. Place the belt comfortably around the waist with the battery near the side-back of the right hip.

Assemble the DLC (Disposable Lens-Cuff)



1. Obtain the appropriate DLC from the DLC dispensing box.



NOTE

Generally, start with the ML (Medium/Large) size face/head cover, unless the user has a particularly small size head.

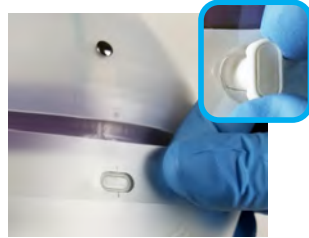

2. Align FCC front TurnClip horizontally, snap the DLC Front Alignment Hole over the TurnClip. Position the TurnClip vertically to lock DLC in place.



3. Align and snap one DLC Side Attachment Hole over the respective FCC Side Attachment Post. Repeat for other side.

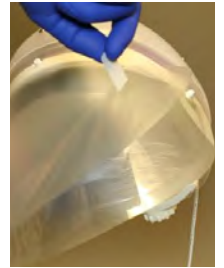

4. Pull the DLC Peel Tab up, over and to the left to remove the Lens Protective Cover off the Lens.

Don the Helmet DLC System



1. Connect Helmet Power Cord to Battery. Push Power Cord Connector into Battery Receptacle until Secure Connection audibly clicks.



2. Loosen the ratchet adjustment knob counter-clockwise to ensure the Helmet will easily fit over the head.



3. Hold the Helmet in one hand, pull the front top edge of the DLC Cuff down, and place your chin into the DLC Cuff. Then, pull the Helmet over and down on to your head.



4. Slide your fingers between the Cuff and face from each temple down and under your chin to pull the DLC Flappers away from the Lens, and to properly position the Cuff.



CAUTION

Optimum setting is achieved when the helmet is secure on the head for all movements required and the front headband is within 1/2 inch of the eyebrows to allow good visualization of the LED Safety Status Indicators in the upper peripheral vision. Be sure to have both Height Adjustment tabs in the same position.

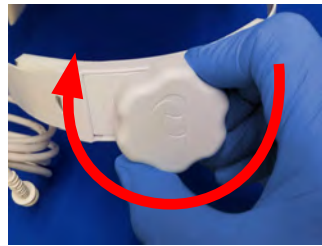
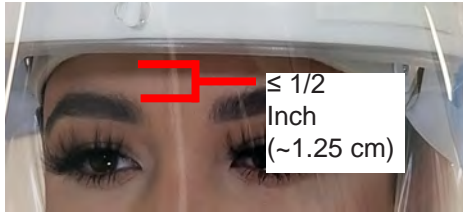

5. Position the Helmet so that the front headband is within 1/2 inch of the eyebrows and the rear headband is resting under the occipital bone above the vertebrae on the neck, and then tighten the Adjustment Knob clockwise to ensure the most secure fit of the Helmet on the head for all activities. Do not over tighten to cause discomfort.



WARNING

If conditions 1 and 2 below both are not achieved, switch to the other size DLC and repeat Assemble the DLC and Don the Helmet DLC System before proceeding.



FCC Side Tabs
DLC Flappers

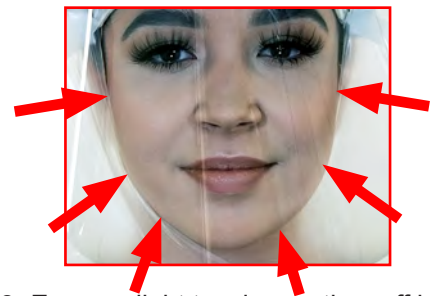

Condition 1: Ensure the DLC Flappers are away from the Lens, positioned perpendicular to your temples, and in front of the Filter Cover Cap (FCC) Side Tabs

Condition 2: Ensure slight tension on the cuff is felt continuously while sliding the index or first finger between the cuff and the face all along the chin and up to the temples, from the right side of the face to the left.



CAUTION

If the Helmet is not secure and comfortable on the head, it may be necessary to change the Height Adjustment.

The Height Adjustment raises and lowers the rear headband and the angle of the helmet with respect to the head, and properly positions the DLC Lens from the chin.

This optimizes a secure and comfortable fit in conjunction with the Adjustment Knob for optimizing the circumference of the Headband.

It also aids in proper positioning for easy visualization of the LED Safety Status Indicators.

If necessary, unsnap the Height Adjustment tabs on each side of the Helmet Liner and reposition upward or downward, until the optimum fit for comfort and security is determined.

Ensure that both tabs are in the same hole position.

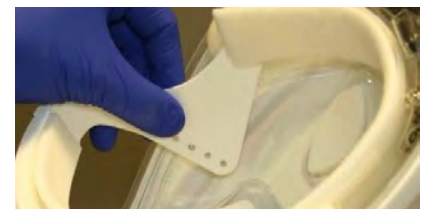

NOTE

Don an outer gown, over the Battery and Belt, per the gown manufacturer's recommendations.

There are two alternative protocols for doffing the DLC System

- Alternative A is doffing the Helmet leaving the DLC attached for the next use.
- Alternative B is removing the DLC for disposal and doffing the Helmet.

Doff the System: Alternative A



1. Loosen the rear Headband Adjustment Knob (turn counterclockwise).



2. Pull the DLC Cuff away from the chin and lift the Helmet up, forward, and off the head.

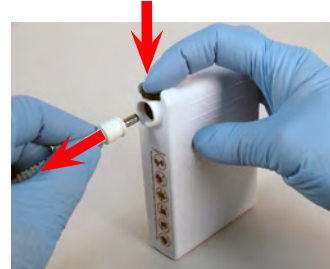

3. Disconnect the Helmet Power Cord from the Battery - push the Secure Connection Button down, pull Cord Connector out, release the Button.



4. Disconnect the Battery Belt from around the waist by un-snapping the buckle.



5. With the Charger connected to the mains wall power, connect the Charger Cord to the Battery. Push the Charger Cord Connector into the Battery Receptacle until it is fully seated.



6. The entire CAPR System may be decontaminated, cleaned and/or stored at this time.

7. If desired, the components of the CAPR System may be disassembled and each component decontaminated, cleaned and/or stored at this time.

Doff the System: Alternative B



1. With the System mounted on head, turn front TurnClip horizontally.



2. Grasp each side DLC at the Flappers; pull outward and unsnap DLC from FCC.



3. Continue pulling outward and forward to release front of DLC from front TurnClip.



4. Continue pulling outward and forward until DLC is completely away from the Helmet. Dispose of DLC per institutional protocol for contaminated waste.



5. Loosen the rear Headband Adjustment Knob by turning it counterclockwise



6. Lift the Helmet up and off the head.

7. Follow steps 3-7 from Alternative A.

11. Comfort Strips

The Comfort Strips, 2000-201, provide comfort and moisture absorption when placed on the front Headband. They may be changed at user discretion for hygiene purposes.

Assembling and Disassembling the Comfort Strips

**NOTE**

Only one side of the comfort strip will attach to the hook tape on the Headband.

1. To remove a damaged or soiled Front Comfort Strip, pull it away and off of the Headband.
2. To attach a new Front Comfort Strip, align it parallel to the Headband with the loop side facing the Headband and press it on.



The Rear Comfort Strip is closed cell foam and may easily be cleaned with a decon wipe and reused until worn or otherwise unsuitable for use.

1. To remove a damaged or soiled Rear Comfort Strip, pull it away and off of the Headband.
2. To attach a new Rear Comfort Strip, align it parallel to the Headband with the loop side facing the Headband and press it on.



12. Li-Ion Battery

Three Secure Lock Battery choices are available, including -

- 2500-36TSC (01532104) - typically 8-10 hours/charge
- 2500-37TSC (01532161) - typically 12-15 hours/charge
- 2500-30TSC (01532116) - typically 16-20 hours/charge

All batteries are handled similar to the 2500-36TSC as indicated in this section.



CAUTION

Inspect the Battery for damage before every use. Do not use if damaged.

Always start with a fully charged Battery and use with the MAXAIR System only.

Fully recharge Batteries immediately after every use.

Charge the Battery only with a MAXAIR Lithium Ion Charger. See the Charger's Instructions for use.

If the Charger LED is red when the Battery is connected, the Battery is not fully charged.

If it is necessary to use a non-fully charged Battery, precede using extreme CAUTION. Take very careful note of the Helmet LED Safety Status Indicators when the Battery is connected to the Helmet Power Cord. Refer to the Helmet LED Safety Status Indicator LED Matrix table in Section 3.6.3 to estimate the amount of useful time remaining on the Battery if it is not in a fully charged condition. Proceed once it is determined that there is sufficient charge in the Battery for the next activity.

Securing the Battery

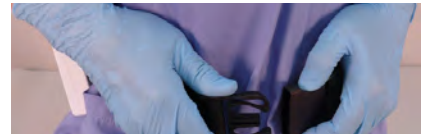
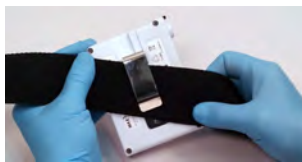

1. Obtain a fully charged battery. (Charger LED should be green after battery is connected to charger for more than 10 seconds.)

2. Assemble the battery onto the belt. Place the top edge of the Belt under the Battery Clip. Move the Belt fully under and up to the top of the Clip.

3. Place the belt comfortably around the waist with the battery near the side-back of the right hip.



CAUTION

Ensure the power cord connector is fully secured into the battery connector socket. Push the cord connector all the way in until the battery connector socket stops further inward movement of the power cord connector.

Handle the power cord by the connector, not the cord.

Connecting the Battery to the Helmet



To initiate air-flow, connect the Helmet Power Cord to the Battery. Push the Power Cord Connector into the Battery Receptacle until the Secure Connection audibly clicks.

Disconnecting the Battery from the Helmet

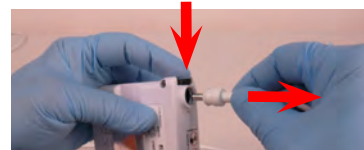

Disconnect the Helmet Power Cord from the Battery - push the Secure Connection Button down, pull Cord Connector out, release the Button.

Material safety data sheet (MSDS) available upon request.

13. Charger



WARNING

The Single Chargers, 2600-01 (01432089) and 2600-02 (01432202), should only be used in an isolated area away from patients and other activities, and away from flammable materials. Inspect the charger for damage before every use. Do not use if damage is apparent or suspect.

A battery should be connected to a charger only until the Charger LED turns Green indicating a fully charged Battery. When the Charger LED turns Green, the Battery should be disconnected from the Charger.

Refer to Section 28 for details regarding intermittent use and storage of batteries.

2600-02



2600-01

Intended Use

1. This Charger is designed for indoor use only and should not come into contact with water or excessive dust. To prevent overheating the product should not be covered during use.
2. The mains socket should be easily accessible. In the event of operational error, the plug should be immediately removed from the socket.
3. This Charger is designed for use with MAXAIR Lithium-Ion Batteries. For safety reasons, this Charger must be used only for MAXAIR Batteries which have the right number of cells in series: Output voltage divided by 4.1V or 4.2V.
4. The Charger contains dangerous voltages and the cover should not be removed.
5. All recommended maintenance work should be carried out by qualified personnel who can get assistance by contacting the manufacturer's agent.
6. A fuse protects the Charger against short circuiting and overloading.
7. This symbol  means that the charger is double insulated (Insulation Class II)
8. If the Charger is mounted in a vehicle it can only be used when the vehicle is not in use.
9. If the Charger is labeled "EN60601-1" and therefore it complies with the requirements of electro-medical equipment, it can be used in hospital environments, etc.
10. The Charger has a plastic casing; avoid its coming into contact with oils, grease etc., as most types of plastic can be broken down by chemicals and solvents.

Charging Instructions



1. Connect the Charger (single and/or 6-Gang) to an appropriate grounded wall mains power source (120-240 VAC, 50-60 Hz) before connecting to the Battery(ies). The Charger green status LED should turn on.



2. Connect the Battery(ies) to the Charger(s) by pushing the Charger Cord Connector into the Battery Connector Receptacle until fully seated. The Charger LED should change from green to red to indicate charging. If the LED is Green after being connected to the Battery for 10 seconds, the Battery is ready for use.



3. When charging is complete, the Charger LED should change to green. Disconnect Battery(ies) from Charger(s) by pulling the Charger Cord Connector from the Battery Connector receptacle. The Battery(ies) is(are) ready for use.



WARNING

The Charger has internal fuses which blow if a fault occurs in the charger. Additionally, the Charger is equipped with a fuse switch which cuts off the unit in the case of a reverse polarity connection to the Battery. If a Charger fails, contact Customer Service at 1-800-443-3842 for a Return Material Authorization (RMA).

2600-01 LED Indicator and Charge Status

Fast charge (Red LED)

- The charger is in constant current mode.
- Charge current is at the maximum.

Final charge (Red LED)

- The charger is in constant voltage mode.
- Charge current is less than the maximum.
- The battery is normally 80-95% charged.
- The charger stays in this mode until the charge current decreases to charge termination level.

Charge completed (Green)

- The charge is stopped.
- Charge current is zero.

Charging Diagram

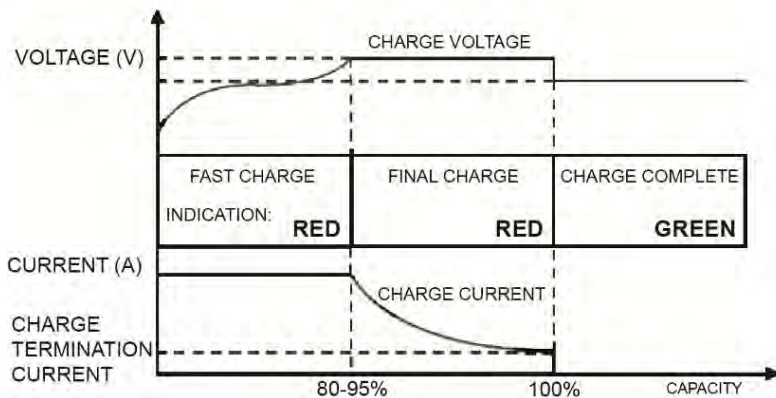

2600-02 LED Indicator and Charge Status

Step 1 - Constant Current Charge cycle starts automatically when connected to mains and battery is connected to charger. Charging is with maximum charger current. The LED is YELLOW. This allows rapid charging to 80-95% capacity.

Step 2 - Constant Voltage (Timer) Charge. Charge voltage is constant and charge current is decreasing. The LED is FLASHING YELLOW. This continues until current has decreased to end of charge detection level of until Timer runs out (8 hours). The battery is charged to full capacity.

Step 3 - Charge Complete. The LED turns GREEN, the battery is fully charged, the charge current is zero, and the battery has been charged to its full capacity. A new charge cycle will be initiated if battery voltage decreases with 0.1 V/cell.

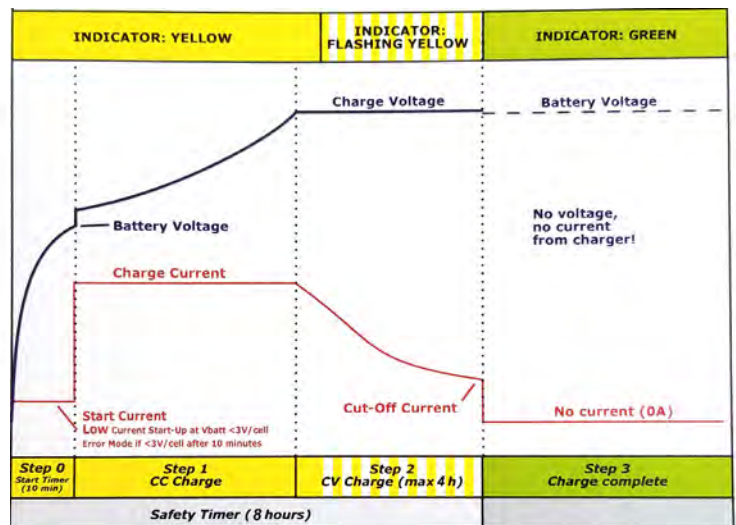

FLASHING GREEN - Battery not connected.

3 Red Blinks - Charger output is shorted.

4 Red Blinks - Battery voltage low and may need replacing.

Charging Protection from Electrical Surges

It is highly recommended to always connect the MAXAIR Charger directly to a Surge Protection Device, adequate for all anticipatable occurrences, during all charging activities of MAXAIR LIBs, and whenever the Charger is connected to a mains power source.

To choose an appropriate surge protector you should consult with your Engineering department regarding specifics to your physical plant and geographical environment. You may want to consider the following common fundamentals -

- ▲ Indicator light – surge protectors will not last forever – when a surge protector properly diverts a surge, the protector itself can be damaged in the process. An indicator light will indicate that the surge protector is working fine.
- ▲ UL Rating - good surge protectors come with a UL rating (or equivalent regulatory mark for non U.S. countries, e.g. CE Mark, etc.), a rating put out by the independent Underwriters Laboratories that tests the safety of electronic devices.
- ▲ Clamping voltage - the voltage measurement that prompts the surge protector to start redirecting the excess electricity away from the plugged-in devices.
- ▲ A surge protector with a lower clamping voltage will trigger earlier, thus better protecting electrical devices.
- ▲ Joule rating - the maximum amount of energy the surge protector can absorb. If the surge exceeds this maximum, the surge protector will be rendered useless. The higher the joule rating, the more energy can be absorbed by the surge protector, therefore, a higher joule rating will often indicate a longer lifespan for the product.



Gang Battery Chargers

2602-06 6-Gang Battery Charger

Includes six 2600-02 Chargers that can be charged simultaneously from one wall power outlet.

2602-06B 6-Gang Charger Bracket

The 6-Gang Charger Bracket is for use with from one to six already purchased 2600-02 Chargers.

Installing the 6-Gang Battery Charger and Bracket

The 6-Gang Charger and 6-Gang Charger Bracket ship with basic mounting hardware for mounting into solid wood and plasterboard.

Locate a suitable location for placing them on a surface. If it is desirable to mount them to a wall, cabinet, etc., use the mounting hardware supplied.

Charging Batteries with the 6-Gang Battery Charger

Plug the power cord into a standard 110v outlet.

If necessary, connect from one to six 2600-02 Chargers into the clips, at any given time, and connect the chargers to the six-connector cable using the 1-6 charger connectors on the power cable.



NOTE

Each connected Charger's LED should be green before a Battery is connected for charging. Connect batteries to appropriate Chargers and the Charger's green LED should turn red.



NOTE

If a charger LED remains red when a Battery is connected, the Battery is charged sufficiently and is ready for use. The Charger LED should change back to green when the Battery is charged, typically in 4-6 hours for a fully drained Battery.

2600-02 (01432202)



Label View



Indicator View



2602-06



2602-06B

14. Helmet

All three CAPR Helmets are shipped with the 2051-07 (01031269) Cage in place to protect the motor-blower assembly:

- 2081-03: 01031001 Helmet, 2071-08 (03531021) Liner, 2051-07 (01031269) Cage, 2590-05 Power Cord
- 2082-03: 01031001 Helmet, 2071-02 (03531104) ChinBar Liner, 2051-07 (01031269) Cage, 2590-05 Power Cord
- 2083-03: 01031001 Helmet, 2071-07 (03531148) Hard Hat Liner, 2051-07 (01031269) Cage, 2590-05 Power Cord



CAUTION

Always place a Filter Cartridge and Filter Cover Cap, or a SnapOn Cage on the Helmet when it is not in use.

Prepping the Helmet for use (2081-03 shown, follow same procedure for other Helmets)

A. For use with MAXAIR Hoods, the Cage remains on the Helmet - Continue with "Setting Air Flow" below.

B. For use with MAXAIR Cuffs and Shrouds continue with instructions immediately below.



SnapOn Cage
2051-07



1. Unsnap the left and right side Snap Tabs of the SnapOn Cage.



2. Unsnap the rear Snap Tab and remove the SnapOn Cage lifting upward and off the Helmet.



3. The helmet is ready to assemble the appropriate Filter Cartridge.

Setting Air Flow

When the Helmet is initially connected to the Battery, all LED Safety Status Indicators light briefly, then the red and yellow LEDs turn off, and airflow increases to the appropriate operating level based on the Air Flow Switch position. The green LEDs will be on as appropriate to the battery charge level.

Adjust the Air Flow Switch relative to the expected activity level and desired comfort level.



Air Flow Switch Position		
Low	Med	High
Air Flow in Liters Per Minute		
190	215	240



NOTE

The flow levels, in liters per minute, are only approximate.

Prepping the Helmet for Storage

1. Clean all dirty surfaces per Section 23.
2. Assemble a Filter Cartridge, Section 12, or the SnapOn Cage, reverse of steps 1-3 directly above, Prepping the Helmet for use.
3. Follow storage instructions per Section 28.

15. Helmet Liner

Follow this same procedure for all MAXAIR CAPR Helmet Liners.



CAUTION

Prior to assembly, inspect and verify the Liner mounting holes (4) are in good condition. If the mounting holes are worn and connections to the helmet are weak or loose, replace the Liner. Always assemble the Helmet Liner to a Helmet that already has a Helmet Protector or Filter Cartridge attached.

Assembly



1. Support the Helmet with one hand and position the Liner inside the Helmet. Adjust the power cord over the power cord slot.



NOTE

The Helmet Liner front should be "caught" in the recessed area, front lip at the Helmet front.

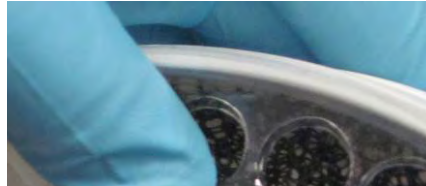

2. Align and place the Liner front bottom edge under and against the front lip of the Helmet.



3. Front Left and Right: Align and snap down the Liner front holes to the Helmet front Snaps with your thumbs.



4. Push the rear edge of the Liner inward with your thumb. Align the rear Liner holes over the Helmet rear snaps.

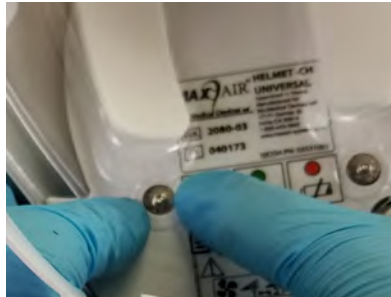

5. Rear Left and Right: Snap the Liner rear holes on to the Helmet rear snaps.



6. Snap the Liner rear lip against the Helmet rear by pressing/squeezing them together.

Disassembly

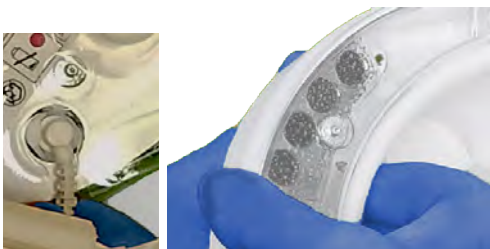

1. Align the Helmet Power Cord to the Liner cord slot. Grasp the Liner headband with fingers, with thumbs against Helmet front.



2. Squeeze and pull up with fingers and push down with thumbs, in opposite directions, to disengage the front mounting snaps.



3. Disengage rear mounting snaps by pulling the Liner top away from the Helmet.

During Use

If the Helmet is not secure and comfortable on the head, it may be necessary to change the Height Adjustment. The Height Adjustment raises and lowers the rear headband and the angle of the helmet with respect to the head, and properly positions the DLC Lens from the chin. This optimizes a secure and comfortable fit in conjunction with the Adjustment Knob for optimizing the circumference of the Headband. It also aids in proper positioning for easy visualization of the LED Safety Status Indicators. If necessary, unsnap the Height Adjustment tabs on each side of the Helmet Liner and reposition upward or downward, until the optimum fit for comfort and security is determined.



CAUTION

Optimum setting is achieved when the helmet is secure on the head for all movements required and the front headband is within 1/2 inch of the eyebrows to allow good visualization of the LED Safety Status Indicators in the upper peripheral vision.

Be sure to have both Height Adjustment tabs in the same position.

16. System Specifications

Specifications listed are approximate and may vary slightly from unit to unit or by power supply fluctuations and/or tolerance of the controller.

CAPR STANDARD SYSTEM		
#	PROPERTY	SPECIFICATIONS (NIOSH)
1	Complete Device Classification	PAPR, Loose Fitting
2	89/686/EEC Complete Device Category	N/A
3	93/42/EEC Complete Device Class	N/A
4	EMC Classification (IEC 60601-1-2: 2007; EN 60601-1-2:2007)	N/A
5	Storage Temperature Range	-
6	Storage Maximum Humidity	-
7	Effective field of vision versus natural field of vision	N/A
8	Overlapped Field of vision versus natural field of vision	N/A
9	Maximum Inward Leakage	N/A
10	Fit Factor	Minimum 500
11	Maximum allowable Percent Leakage: Dioctyle-Phthalate Test	0.03% @ 107 LPM
12	Minimum allowable NaCl efficiency	99.97% @ 125 lpm
13	Maximum Breathing Resistance	N/A
14	Minimum Airflow	170 LPM
15	Battery	-
16	Noise Level	80 dBA limit
17	Total Mass/ Total Mass on Head	-
18	2167-10 Filter Classification	HE*

*=Equivalent

**= NIOSH approved HE protection filters can be used for protection against particulate aerosols containing oil. However, for reliable operation and desirable useful run time, Bio-Medical Devices Intl does not recommend Filter Cartridge use against particulate aerosols containing oil.

2500-30TSC/ 2500-37TSC/ 2500-36TSC/2561-01 Battery Specification			
IPXO Ordinary Equipment			
Duty Cycle: Continuous Operation.			
#	PROPERTY	SPECIFICATIONS	
		All Filters excluding 2166-10	Filter 2166-10
1	Minimum Continuous Operating Time: 2500-36TSC	4 Hrs. (Typical 4-10 hr./Charge)	N/A
2	Minimum Continuous Operating Time: 2500-37TSC, 2561-01	6 Hrs. (Typical 6-15 hr./Charge)	4 Hrs. (Typical 4-9 hr./Charge)
3	Minimum Continuous Operating Time: 2500-30TSC	8 Hrs. (Typical 8-20 hr./ Charge)	6 Hrs. (Typical 6-14 hr./Charge)
4	Charge Input	16.8V; 1A	
5	Electrical Output: 2500-36TSC	14.8V; 2.25Ah	
6	Electrical Output: 2500-37TSC, 2561-01	14.8V; 3.35Ah	
7	Electrical Output: 2500-30TSC	14.8V; 4.50Ah	
2600-01 Charger Specification			
#	PROPERTY	SPECIFICATIONS	
1	Complete Charge for 2500-36TSC, 2500-37TSC, 2561-01, or 2500-30TSC	4-6 Hours for a Fully Drained Battery	
2	Electrical Output	Up to 16.8V; Up to 0.9A	
3	Electrical Input	100-240 VAC; 50-60Hz; 0.3A	

MAX  **AIR**®

SYNTECH INTL

17171 Daimler Street • Irvine, CA 92614 • 800-443-3842 • www.syntech-intl.com